

GRUNDIG

Cooker hood

User Manual

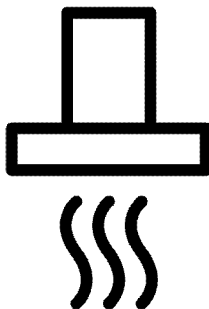

GDI 5795 BXB

EN

185.7302.07/R.AC/21.06.2021

7702389207

Please read this user manual first!

Dear Customer,

Thank you for purchasing this Grundig product. We hope that you get the best results from your product which has been manufactured with high quality and state-of-the-art technology. Therefore, please read this entire user manual and all other accompanying documents carefully before using the product and keep it as a reference for future use. If you handover the product to someone else, give the user manual as well. Follow all warnings and information in the user manual.

Remember that this user manual is also applicable for several other models. Differences between models will be identified in the manual.

Explanation of symbols

Throughout this user manual the following symbols are used:

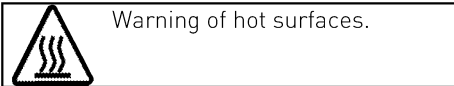
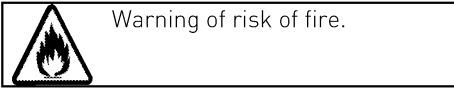
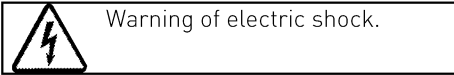
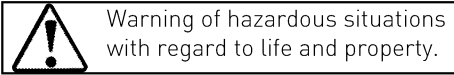
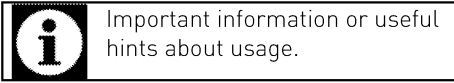

Arçelik A.Ş.
Karaağaç caddesi No:2-6
34445 Sülüce/Istanbul/TURKEY
Made in TURKEY

TABLE OF CONTENTS

1 Important instructions and warnings for safety and environment **4**

General safety	4
Electrical safety	5
Product safety	6
Intended use	7
Children's safety	7
Disposing of the old product	8
Package information	8

2 General information **9**

Overview	9
Scope of delivery	10
Technical specifications	10

3 Installation **11**

Installation	11
Future transportation	12

4 Operating the hood **16**

Controller	18
------------------	----

5 Maintenance and care **22**

General information	22
Replacing the lamp	23

6 Troubleshooting **24**

1 Important instructions and warnings for safety and environment

This section contains safety instructions that will help protect from risk of personal injury or property damage. Failure to follow these instructions shall void any warranty.

General safety

- **Risk of Toxicating!** While the appliance is operating, air in the entire house is sucked. If adequate ventilation is not provided, waste and toxic gasses which are released as a result of burning will be drawn back into the house through chimney draught. Do not operate the appliance together with sources that may emit toxic gasses and create air draught (wood, gas, oil, and coal stoves, water heaters, kettles, etc.).
- Always have the authorized persons check the adequacy of ventilation and chimney draught in your building.
- The appliance is not intended for use by persons (including children) with reduced physical, sensory or mental capabilities, or lack of experience and knowledge, unless they have been given supervised or instruction concerning use of the appliance by a responsible person for their safety. Young children should be supervised to ensure that they do not play with the appliance. Cleaning and user maintenance procedures should not be performed by the children unless they are under supervision.
- Always have the installation and repair procedures performed by **Authorised Service Agent**. Manufacturer shall not be held responsible for damages arising from

procedures carried out by unauthorised persons.

- Do not operate the appliance if it is defective or has any visible damage.
- Make sure that the appliance is switched off after every use.
- Appliance must be installed by a qualified person in accordance with the regulations in force. Otherwise, the warranty shall become void.

Electrical safety

- To get your product ready for use, firstly you must have installation place and electric wiring prepared. Later, you may call Authorised Service nearest to you.
- If it has a failure, the product should not be operated without being repaired by the Authorised Service Agent. There is the risk of electric shock!
- Never plug the hood before installation is completed.
- Never touch the plug with wet hands! Do not unplug by pulling from the cable;

always grab by the plug to unplug.

- Product must be disconnected from the mains during installation, maintenance, cleaning and repair procedures.
- If the supply cord is damaged, it must be replaced by the manufacturer or its service agent or a similarly qualified person in order to avoid a hazard.
- Never connect power cable near to the hobs. If melted down, cable may lead to fire.
- Any work on electrical equipment and systems may only be carried out by authorised and qualified persons.
- In case of any damage, switch off the product and disconnect it from the mains. To do this, turn off the fuse at home.
- Make sure that fuse current is compatible with the product.
- Never wash down the product with water! There is the risk of electric shock!

Product safety

- The height between the lower surface of the hood and upper surface of the hob should not be less than 650 mm.
- Never touch the hood's lamp after they operated for a long time. Hot lamps may burn your hands.
- Never operate the product without oil filter. Never remove filters when the product is in use.
- Avoid big flames beneath the product. Otherwise, particles on oil filter may flame up and cause fire.
- Turn on the hobs after placing pans or pots on. Otherwise, rising temperature may deform certain parts of your product.
- Turn off the hobs before taking away pans or pots.
- Avoid inflammable materials under the hood.
- Do not expose the product to open flames beneath it. It can cause oils accumulated in the filter to catch fire. Do not operate the product without filter.
- Never leave the cooker unattended when frying foods, the oil may flame up and boiled oil may cause fire. Thus, be careful about cloths and curtains.
- If the hood is not periodically and properly cleaned, this may cause burning risk on your hood.
- For refreshing the kitchen's air from cooking smells and steams, please turn on your hood for 15 minutes more after cooking or frying has ended.
- There shall be adequate ventilation of the room when the range hood is used at the same time as appliances burning gas or other fuels. (Not applicable to appliances that only discharge the air back into the room)
- In the environment where the hood is being used, the exhaust of fuel oil or gas devices such as room heater must be absolutely insulated or device must be hermetical type.

- If there is a fuel oil or gas device in the environment, the room must be ventilated sufficiently.
- When a non-electrically operated device is concurrently used in the environment together with the hood, the negative pressure in the room must be maximum 0.04 mbar to avoid the hood's returning other device's exhaust into the room.
- Never connect the hood to the chimneys used for heaters, waste gas or with rising flames. Observe authorities' regulations on the draining of output air.
- When connecting to the chimney, use 120-mm diameter pipes. Pipe connection must be as short as possible with fewer bends.
- Do not hang easily flammable and combustible materials on hood handles.
- Our company shall never be responsible for the problems arising from the

use against the warnings above.

- There is a risk of fire if cleaning is not carried out in accordance with the instructions.
- Do not flambé under the range hood.
- Caution: Accessible parts may become hot when used with a cooking appliance.
- You are recommended to clean your filter once a month in normal use.

Intended use

This product is designed for domestic use. Commercial use is not admissible.

The manufacturer shall not be liable for any damage caused by improper use or handling.

Children's safety

- Keep children away from the product when it is operating and do not allow them to play with the product.
- Packaging materials are dangerous to children. Keep the packaging materials in a place where children cannot reach and

sort and discard them in accordance with the waste disposal directives.

- Electrical products are dangerous to children. Keep children away from the product when it is operating and do not allow them to play with the product.

Disposing of the old product

Compliance with the WEEE Directive and Disposing of the Waste Product:



This product complies with EU WEEE Directive (2012/19/EU). This product bears a classification symbol for waste electrical and electronic equipment (WEEE). This product has been manufactured with high quality parts and materials which can be reused and are suitable for

recycling. Do not dispose of the waste product with normal domestic and other wastes at the end of its service life. Take it to the collection center for the recycling of electrical and electronic equipment. Please consult your local authorities to learn about these collection centers.

Compliance with RoHS Directive:

The product you have purchased complies with EU RoHS Directive (2011/65/EU). It does not contain harmful and prohibited materials specified in the Directive.

Package information

- Packaging materials of the product are manufactured from recyclable materials in accordance with our National Environment Regulations. Do not dispose of the packaging materials together with the domestic or other wastes. Take them to the packaging material collection points designated by the local authorities.

2 General information

Overview

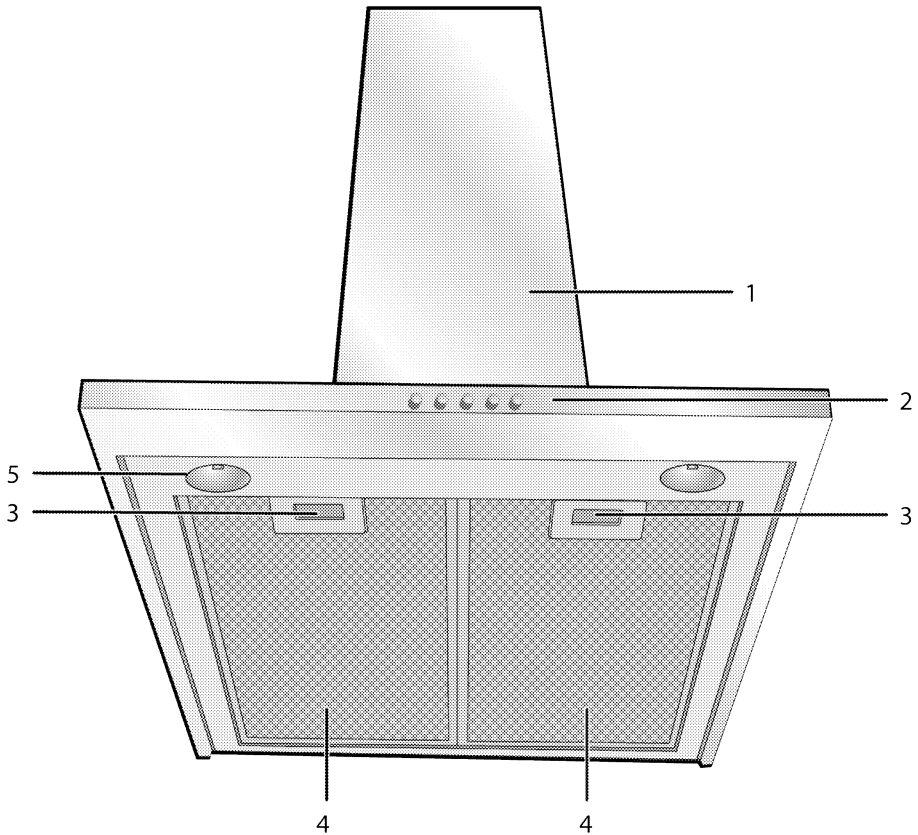

- 1 Hood body
- 2 Control panel
- 3 Aluminum filter lock
- 4 Aluminum filter
- 5 Lamp

Scope of delivery

i Accessories supplied can vary depending on the appliance model. Not every accessory described in the user manual may exist on your appliance.

1. User manual
2. Wall connector

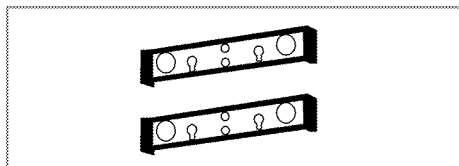

3. Air directing component optional

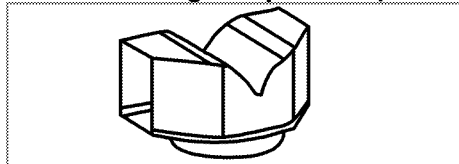

4. Chimney connection adapter

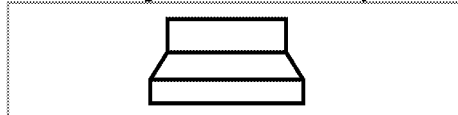

5. Valves to prevent reverse air flow

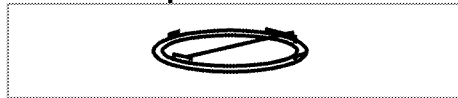

6. Distance ring



Technical specifications

External dimensions (height/width/depth)	min. 760 mm max. 915 mm/898 mm/490 mm
Voltage/frequency	220-240 V ; 50 Hz
Control	3 level + 1 Booster
Suction power	750 m ³ /h
Total power consumption	max. 225 W
Fuse	min. 10 A
Air outlet pipe diameter	120 - 150 mm

i Technical specifications may be changed without prior notice to improve the quality of the product.

i Figures in this manual are schematic and may not exactly match the product.

i Values stated on the markings of the product or in other printed documents supplied with the product are obtained under laboratory conditions as per relevant standards. Depending on operational and environmental conditions of the product, these values may vary.

3 Installation

Refer to the nearest Authorised Service Agent for installation of the product. Make sure that the electric installations are in place before calling the Authorised Service Agent to have the product ready for operation. If not, call a qualified electrician and fitter to have the required arrangements made.

i Preparation of location and electrical installation for the product is under customer's responsibility.

! DANGER:
The product must be installed in accordance with all local electrical regulations.

! DANGER:
Prior to installation, visually check if the product has any defects on it. If so, do not have it installed. Damaged products cause risks for your safety.

! DANGER:
Warning: Failure to install the screws or fixing device in accordance with the instructions may result in electrical hazards.

Installation

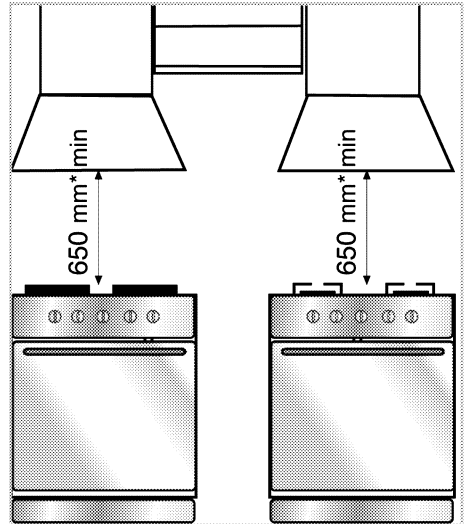

* min.

The minimum distance between the supporting surface for the cooking vessels on the hob and the lowest part of the range hood is 65cm.

The exhaust air must not be discharged into a flue which is used for exhausting fumes from other appliances burning gas or other fuels. (Not applicable for appliances which only discharge air back into the room)

Regulations concerning the discharge of air have to be fulfilled.

Electrical connection

Manufactured with 2-track power cable, this device must be connected to the mains by an electrical switch with at least 3mm clearance between bipolar contact

leads. Have a qualified electrician to install electric wiring.

- An earthed outlet must be installed on basis of the installation location of the chimney or hood.

Installing the hood



Measurements are in mm.

The following provides necessary information to prepare the location for hood installation.

Before installation, determine the total height of the hood carrier assembly and mark the holes for installation on the ceiling.

1. Center the cooker and determine your central point on the ceiling. Mark the points to drill by using the template and drill 4 x 8 mm holes.

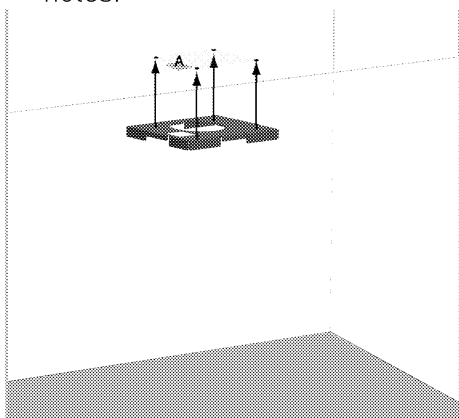

2. Mount the sheet comprising the top piece of the carrier elements supplied with the product in a way that it matches with these holes. When making electrical connection, an outlet must be

installed in a way that it matches with section A indicated in the above figure. There is a gap in this section of the sheet.

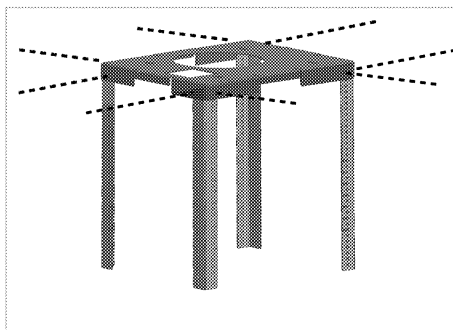

3. Secure 4 pieces of intermediary carrier pieces by screwing them to the top sheet from 8 points as indicated in the above figure.

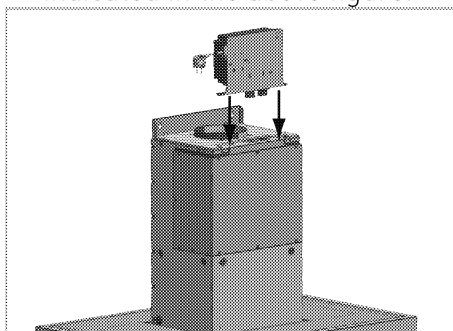

4. For use with chimney connection:

In chimney-connected position, absorbed air will go through oil filters to the outlet and then will reach to the chimney through connection pipes and finally thrown out from the chimney.

There must be a chimney hole on the ceiling for use with chimney connection.

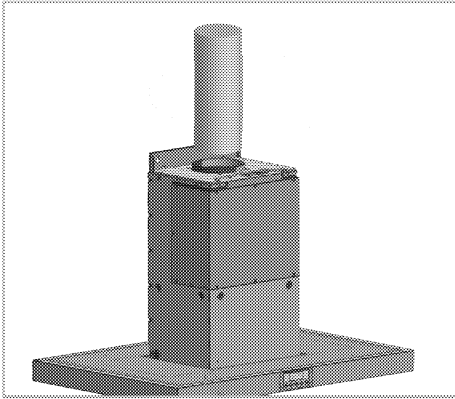

When using this connection position, the connection piece indicated in the figure must be installed on chimney outlet flange.

Chimney connection pipes must be made of fireproof plastic material. When using flexible connection type, it should be considered that sharp corners and sudden contractions will have a negative impact on air suction.

The hood must never be connected to a chimney to which another device was already connected.

i Connection pipe should not be bigger than 120 mm; on the contrary, this application prevents proper chimney connection.

5. Internal circulation (Use with carbon filter)

In the position of internal circulation, the absorbed air will go through oil filters and carbon filters, where the smell is eliminated, and through air directing component. Later, it is finally sent back to the

environment through the grates on chimney.

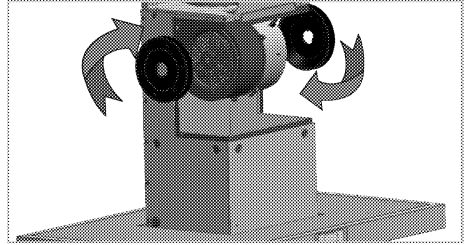

To attach the carbon filters, remove the sheet on the hood body by removing its screws. Place ear slots of carbon filters (L) to the ears on motor carrier (M) as shown in the above figure and turn counterclockwise to fix in place. Apply the same procedure for the motor carrier on the other side.

i Failure to clean and service oil filters periodically and failure to replace carbon filters at the end of service life (approximately 4 months) may have the risk of causing fire.

6. Install the air deflector B as indicated in the following figure.

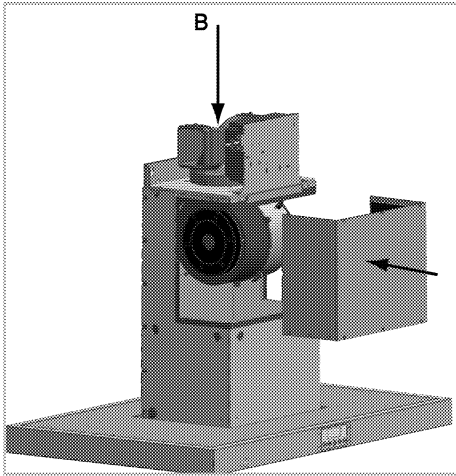

Install the hood body sheet and tighten its screws.

8. Secure the 4 pieces of sheet comprising the lower carrier onto the edges of the hood body by using 16 screws, 8 at the bottom and 8 at the top.

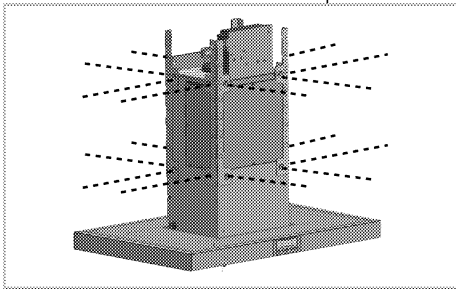

9. Fix the connection sheets on the hood body and the connection sheets fixed to the top sheet that was fixed to the ceiling to each other in a way that they reside 650 mm above the hob surface. Each sheet must be fixed with 2 screws.

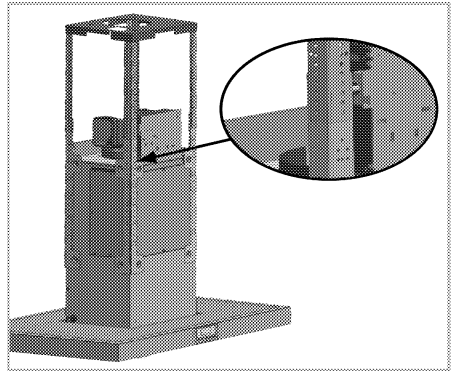

10. Secure the top front and rear cover sheets of the hood body with 7 screws, 3 on each side and 1 on the middle as indicated in the following figure. Rear sheet must also be secured with 7 screws in the same way.

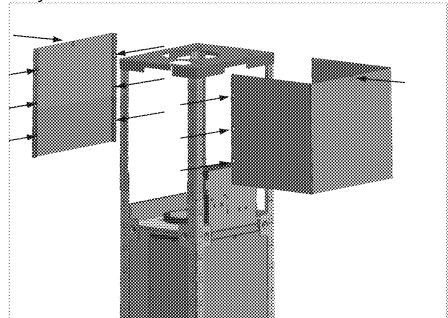

11. Secure the bottom front and rear cover sheets of the hood body with 8 screws, 4 on each side and 1 on the middle as indicated in the following figure. Rear sheet must also be secured with 8 screws in the same way.

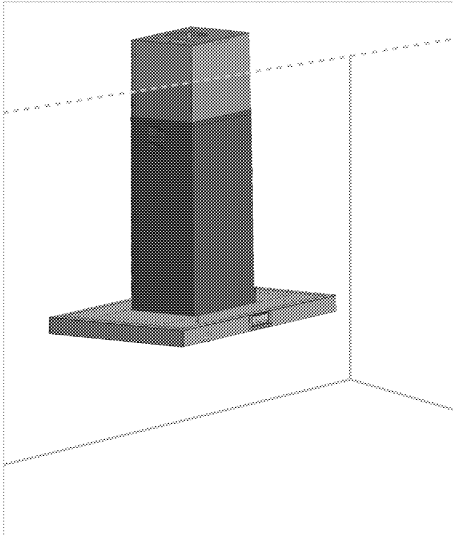
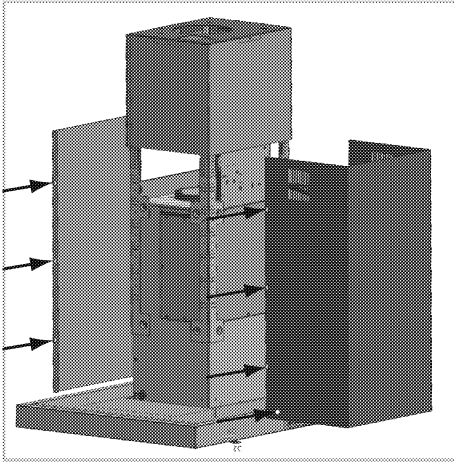

You may use the hood in two ways:

1- Use with chimney connection

The steam is thrown out via chimney pipe which is secured to the connection ring on the hood. Diameter of chimney pipe should be

equal to connection ring. To allow the air easily going out of the room in horizontal arrangements, the pipe should be slightly tilted upwards (approximately 10°).



If the carbon filter is installed on your hood, it must be removed.

2- Use with no chimney connection

Air is filtered through carbon filter and returned to the room. Carbon filter is used when there is no chimney in the house or when it is impossible to install a chimney pipe.

- Install the carbon filter as described in item 6 in installation section.

Future transportation

- Keep the product's original carton and transport the product in it. Follow the instructions on the carton. If you do not have the original carton, pack the product in bubble wrap or thick cardboard and tape it securely.



Do not place any objects onto the product and move it in upright position.



Check the general appearance of your product for any damages that might have occurred during transportation.





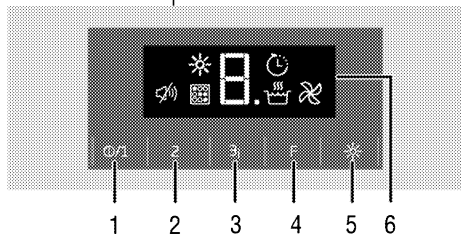

4 Operating the hood

Hood is equipped with a motor with various speed settings.

For a better performance, we advise you to use low speeds in normal conditions, and high speeds when smell and vapors are intensified.





- 1 On/off button / Speed1
- 2 Speed2
- 3 Speed3 / Booster
- 4 Function key
- 5 Lamp key
- 6 Display

-  Auto off symbol
-  Booster symbol
-  Filter full warning symbol
-  Air filter mode symbol
-  Quiet mode symbol
-  Lamp symbol

Operating the hood

1. To turn on the hood, touch the on/off key.
2. To change the speed, touch Speed2 and Speed 3 keys.
» Speed level of the hood shall be displayed.

 Do not touch both keys simultaneously. If touched, higher speed will be activated.

 Appliance operates for a maximum of 6 hours when no key is touched while it is operated.

Auto off mode

1. Touch the function key when the appliance is operated at a certain speed. Auto off mode will be activated and  symbol is displayed.
2. Appliance shall be turned off automatically after operating for 20 minutes at the set level.

 Auto off mode is canceled when any level key other than the lamp key is pressed.

Activating intense ventilation mode (Booster)

Touch the speed3 key for more than two seconds. Intense ventilation mode will be activated and P and  symbol shall be displayed, and the appliance will be active for maximum 10 minutes. After 10 minutes, it will continue to operate in Speed 3 position.
During intense ventilation, if any of the speed keys is touched then the operation will continue in that speed level.

Turning off the hood

1. Touch on the Off key when the hood is operating in a certain speed.

» When the hood is being turned off, "0" is flashed on the display for 8 seconds while motor is being stopped. This is not an error.

Operating the lamp

1. Touch the lamp key to turn on the lamp.

Lamp illuminates and ☀ symbol is displayed.

Turning off the lamp

1. To turn off the lamp, press the lamp switch with short intervals until ☀ symbol disappears.

Lamp is turned off and the ☀ symbol on the display disappears.

 Off key does not turn off the lamp, it only stops operation of the hood.

Changing the lamp light level

You can set the lamp to 3 levels.

1. Press the lamp button and then it will turn on and 1st level is selected. Press the lamp button to increase the lighting level. Each press will increase the level by 1. After the last level, the lamp will turn off.

Air filter mode

1. Touch the function key when the appliance is not operated at any speed.

» Air filter mode will be activated and C and  symbol is displayed.

2. Air filter mode will operate for 10 minutes at speed 1 level and then stops for 50 minutes within 1 hour. If the air filter mod will not turned off, it will continue to operate for 10 minutes and stops 50 minutes for each each hour during 24 hours.

 You can utilize air filter mode to remove odor found in-house in long term using low speed.

Turning off the air filter mode

1. Turn off the air filtering mode by touching any speed key or touching the off key while the air filtering mode is active.

 While the air filter mode is active, when you turn on and off the appliance at any speed level, air filter mode shall not be remembered.

 While the air filter mode is active, the program will be canceled if there is a blackout.

Filter full warning



After every 100 hours operation, F symbol and the set level flashes in turn on the display. Also,  symbol appears on display. Clean your filter. Filter full warning will not reset automatically after cleaning. Filter full warning may be reset by pressing function and speed3 buttons for 3 seconds simultaneously.



When the hood gave filter full warning, the warning will not be reset if there is a blackout.

Quiet mode

You may prevent key clicks from the hood by activating the quiet mode.

Touch the function key until  symbol is displayed to switch to quiet mode. Touch the function key until  symbol is disappeared from the display to cancel the quiet mode.

Controller

You may also control your appliance with the remote controller.

The dot sign on the display flashes twice for each operation of the controller keys when the hood is operated with the controller



On/off button

Increase speed button

Decrease speed button

Air filter mode button

Auto off button

Booster button

Filter full warning off button

Quiet mode button

Quiet mode cancel button

Lamp button

Lamp lighting level increase button

Lamp lighting level decrease button

Operating the hood with the controller

1. To turn on the hood, touch the on/off key on the controller.
» Hood starts to operate at speed 1.
2. Press Speed increase and/or Speed decrease buttons to change the speed level.
» Speed level of the hood shall be displayed.



Never press on two buttons at the same time.





Appliance operates for a maximum of 6 hours when no button is pressed while it is operated.

Turning off the hood with the controller

1. Press on the on/off key on the controller when the hood is operating in a certain speed.
» When the hood is being turned off, "0" is flashed on the display for 8



seconds while motor is being stopped. This is not an error.

Turning the auto off mode on with the controller

1. Press the  button on the controller while the appliance is operated at a certain speed. Auto off mode will be activated and  symbol is displayed.
2. Appliance shall be turned off automatically after operating for 20 minutes at the set level.

 Auto off mode is canceled when a speed level other than the level that the appliance is being operated is set.

Activating intense ventilation mode (Booster) with the controller



Press the  button on the controller while the appliance is operated at any speed level. Intense ventilation mode will be activated and P and  symbol shall be displayed, and the appliance will be active for maximum 10 minutes. After 10 minutes, it will continue to operate in Speed 3 position. Press speed increase or decrease buttons to quit the intense ventilation mode. Operation will continue in the selected speed level.

Operating the lamp with the controller

1. Press on the button  to operate the lamp.

» Lamp illuminates and  symbol is displayed.

Turning off the lamp with the controller

1. Press on the lamp  again to turn off the lamp.
» Lamp is turned off and the  symbol on the display disappears.

Changing the lamp light level via the controller



You can set the lamp to 3 levels.

1. Pressing + switch will increase the lighting level.
2. Pressing - switch will decrease the lighting level.

 You may turn the lamp on and off while hood is turned off.

 On/Off button does not turn off the lamp, it only stops operation of the hood.

Turning the air filtering mode on with the controller

1. When the appliance is not operated, press  button without pressing on/off button on the controller.
» Air filter mode will be activated and C and  symbol is displayed.
2. Air filter mode will operate for 10 minutes at speed 1 level and then stops for 50 minutes within 1 hour. If the air filter mod will not turned off, it will continue to operate for 10 minutes and stops 50 minutes for each each hour during 24 hours.

 You can utilize air filter mode to remove odor found in-house in long term using low speed.

Turning the air filtering mode off with the controller

1. Turn off the air filtering mode by pressing speed increase, on/off key or  key while the air filtering mode is active.

 While the air filter mode is active, when you turn on and off the appliance at any speed level, air filter mode shall not be remembered.

 While the air filter mode is active, the program will be canceled if there is a blackout.

Turning off the filter full warning with the controller



After every 100 hours operation, F symbol and the set level flashes in turn on the display. Also,  symbol appears on display. Clean your filter. Filter full warning will not reset automatically after cleaning.

Press the  button on the control to turn off the filter full warning.

 When the hood gave filter full warning, the warning will not be reset if there is a blackout.

Activating the quiet mode with controller

You may prevent key clicks from the hood by activating the quiet mode. Press the  button on the controller to switch to quiet mode.

 Symbol appears on display. Press  button to activate key clicks by canceling the quiet mode.  symbol disappears.

Replacing the battery of the controller

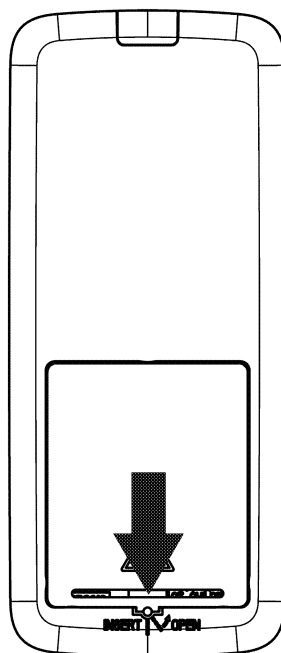

1. Remove the cover from the point indicated with arrow and open the battery compartment.
2. Place the CR2016 type battery.
3. Close the cover of battery compartment.

 Batteries may be dead if your appliance does not react completely to the commands given by the controller. Discharged batteries shall never be kept in battery compartment.



Manufacturer shall not be held responsible for damages caused by used batteries.

Note on the environment



This symbol, available on the battery or on the product package, indicates that the battery delivered with this product shall not be considered as universal waste. This symbol may be used with a chemical symbol on some batteries.

HG chemical symbol is added if the amount of mercury in the batteries is higher than 0.0005%; and Pb chemical symbol is added if the amount of lead in the batteries is higher than 0.004%. Including the ones without heavy metals, batteries shall not be disposed with household waste. Please dispose of used batteries in an environmentally friendly manner. Learn the regulations in your local area.

5 Maintenance and care

General information

Service life of the product will extend and frequent problems will decrease if the product is cleaned at regular intervals.



DANGER:

Disconnect the product from mains supply before starting maintenance and cleaning works.

There is the risk of electric shock!

- Clean the product thoroughly after each use. In this way it will be possible to remove cooking residues more easily, thus avoiding these from burning the next time the appliance is used.
- No special cleaning agents are required for cleaning the product. Use warm water with washing liquid, a soft cloth or sponge to clean the product and wipe it with a dry cloth.
- Do not use cleaning agents that contain acid or chloride to clean the stainless or inox surfaces and the handle. Use a soft cloth with a liquid detergent (not abrasive) to wipe those parts clean, paying attention to sweep in one direction.



The surface might get damaged by some detergents or cleaning materials.

Do not use aggressive detergents, cleaning powders/creams or any sharp objects during cleaning.



Do not use steam cleaners for cleaning.

Aluminum filter

This filter captures oil particles in the air. **You are recommended to clean your filter once a month in normal use.** Please firstly remove aluminum filters for this process. Wash the filters in liquid-detergent water and install them after drying. Aluminum filters might change colour in time due to washing. This is normal and you don't need to replace the filter.

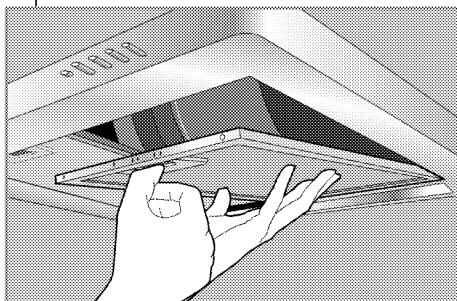

You can also wash aluminum filters in dishwasher.

Removing aluminum filters

1. Push aluminum filter lock forward.
2. Slightly lower the filter and pull forth. Otherwise, you may bend the filter.
3. After washing, reverse the steps above to re-install the aluminum filter.

Carbon filter (Use without chimney)

i Carbon filter should never be washed.

It should be replaced once every 4 months in normal use. You may obtain carbon filters from the Authorised Service.

Replacing the lamp

! **DANGER:**
Before replacing the lamp, make sure that the product is disconnected from mains in order to avoid the risk of an electrical shock. If hot, let the lamp cool down.
Hot surfaces may cause burns!

i For the specifications of the lamp, see *Technical specifications, page 10*. Oven lamps can be obtained from Authorised Service Agents.

i The hood lamp in this product can be changed by the user.

i Position of lamp might vary from the figure.

i The lamp used in this appliance is not suitable for household room illumination. The intended purpose of this lamp is to assist the user to see foodstuffs.

1. Remove the lamp pressing it towards its seat in clockwise direction (1) and then remove turning it in counterclockwise direction (2).

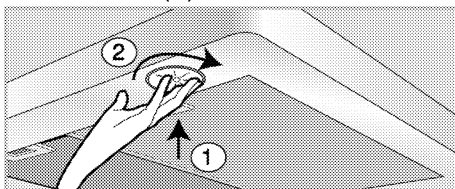

2. Insert the new lamp turning it in clockwise direction.
3. A “click” will be heard when the lamp is secured in its place.

6 Troubleshooting

Product does not operate.

- The mains fuse is defective or has tripped. →→→ *Check fuses in the fuse box. If necessary, replace or reset them.*
- Product is not plugged into the socket. →→→ *Check the plug connection.*
- Speed button might not be set. →→→ *Press the required speed button.*
- Power is cut. →→→ *Check if there is power. Check the fuses in the fuse box. If necessary, replace or reset the fuses.*

Hood light does not work.

- Hood lamp is defective. →→→ *Replace the hood lamp.*
- Power is cut. →→→ *Check if there is power. Check the fuses in the fuse box. If necessary, replace or reset the fuses.*



Consult the Authorised Service Agent or the dealer where you have purchased the product if you cannot remedy the trouble although you have implemented the instructions in this section. Never attempt to repair a defective product yourself.

