

GRUNDIG

Washing Machine

User Manual



GWN 37430



Please read this user manual first!

Dear Customer,





Thank you for preferring a Grundig product. We hope that you get the best results from your product which has been manufactured with high quality and state-of-the-art technology. Therefore, please read this entire user manual and all other accompanying documents carefully before using the product and keep it as a reference for future use. If you handover the product to someone else, give the user manual as well. Follow all warnings and information in the user manual.

Remember that this user manual is also applicable for several other models.

Differences between models will be identified in the manual.

Explanation of symbols

Throughout this user manual the following symbols are used:

	Important information or useful hints about usage.
	Warning for hazardous situations with regard to life and property.
	Warning for electric shock.
	Packaging materials of the product are manufactured from recyclable materials in accordance with our National Environment Regulations.

Do not dispose of the packaging materials together with the domestic or other wastes. Take them to the packaging material collection points designated by the local authorities.



Allergy UK is the operational name of **The British Allergy Foundation**. The Seal of Approval endorsement, which indicates that the product bearing it specifically restricts / reduces / removes allergens from the environment of the allergy sufferer or has significantly reduced allergen content, was created in order to provide guidance for people king advice in this issue. It is aimed to assure people that products had been scientifically tested or reviewed with measurable results.

TABLE OF CONTENTS

Important instructions for safety and environment	4	Operation	22
General safety	4	Control panel	22
Electrical safety	5	Preparing the machine	22
Product safety.	6	Programme selection	22
Intended use	6	Programmes	22
Children's safety.	7	Special programmes	24
Compliance with the WEEE Directive	8	Temperature selection	24
Package information	8	Selecting the spin speed	24
Your washing machine	9	Programme and consumption table	25
Overview	9	Auxiliary function selection.	26
Package Contents	10	End Time	27
Technical specifications	11	Starting the programme	27
Installation	12	Door lock.	28
Appropriate installation location	12	Changes after programme has started	28
Removing packaging reinforcement	12	Child Lock	28
Removing the transportation locks	12	Cancelling the programme.	29
Connecting water supply.	13	End of programme.	29
Connecting to the drain	13	Setting volume level.	29
Adjusting the feet	14	Your machine is equipped with a "Standby Mode"	29
Electrical connection.	15	Quick User Guide	30
Preparation	16	Preparing the machine	30
Sorting the laundry	16	Programme selection	30
Preparing laundry for washing.	17	Auxiliary function selection.	30
Things to be done for energy saving	17	Starting the programme	30
Initial use.	17	End of programme.	30
Correct load capacity.	18	Cancelling the programme.	30
Loading the laundry.	18	Child Lock	30
Using detergent and softener.	18	Maintenance and cleaning	31
Tips for efficient washing	20	Cleaning the detergent drawer.	31
		Cleaning the loading door and the drum	31
		Cleaning the body and control panel	31
		Cleaning the water intake filters	32
		Draining remaining water and cleaning the pump filter.	32
		If the product has an emergency draining hose, to discharge the water:	33
		Troubleshooting	34

Important instructions for safety and environment

This section contains safety instructions that will help protect from risk of personal injury or property damage. Failure to follow these instructions shall void any warranty.

General safety

- This product can be used by children at and above **8** years old and by persons whose physical, sensory or mental capabilities are not fully developed or who lack experience and knowledge provided that they are supervised or trained on the safe usage of the product and the risks it brings out. Children must not play with the product. Cleaning and maintenance works should not be performed by children unless they are supervised by someone. Children of less than 3 years should be kept away unless continuously supervised.
- Never place the product on a carpet-covered floor. Otherwise, lack of airflow beneath the machine will cause electrical parts to overheat. This will cause problems with your product.
- Always have the repairing procedures carried out by the **Authorised Service Agent**. Manufacturer shall not be held liable for damages that may arise from procedures carried out by unauthorised persons.

Electrical safety

- If the product has a failure, it should not be operated unless it is repaired by the Authorised Service Agent. There is the risk of electric shock!
- This product is designed to resume operating in the event of powering on after a power interruption. If you wish to cancel the programme, see "Cancelling the programme" section.
- Connect the product to a grounded outlet protected by a 16 A fuse. Have the grounding installation made by a qualified electrician. Our company shall not be liable for any damages that will arise when the product is used without grounding in accordance with the local regulations.
- Unplug the product when not in use.
- Never wash the product by spreading or pouring water onto it! There is the risk of electric shock!
- Never touch the plug with wet hands! Never unplug by pulling on the cable, always pull out by grabbing the plug.
- Unplug the product during installation, maintenance, cleaning and repairing procedures.
- If the power cable is damaged, it must be replaced by the manufacturer, after sales service or a similarly qualified person (preferably an electrician) or someone designated by the importer in order to avoid possible risks.

Product safety

- The water supply and draining hoses must be securely fastened and remain undamaged. Otherwise, there is the risk of water leakage.
- Never open the loading door or remove the filter while there is still water in the drum. Otherwise, risk of flooding and injury from hot water will occur.
- Do not force open the locked loading door. The loading door will be ready to open just a few minutes after the washing cycle comes to an end. In case of forcing the loading door to open, the door and the lock mechanism may get damaged.
- Use detergents, softeners and supplements suitable for automatic washing machines only.
- Follow the instructions on the textile tags and on the detergent package.
- Place the product on a rigid, flat and level surface.
- Do not place it on a long-pile rug or similar surfaces.
- Do not place the product on a high platform or near the edge on a cascaded surface.
- Do not place the product on the power cable.
- Never use sponge or scrub materials. These will damage the painted, chrome plated and plastic surfaces.

Intended use

- This product has been designed for domestic use. It is not suitable for commercial use and it must not be used for anything other than its intended use.
- Use the product only for washing and rinsing of textile products that are marked accordingly.
- The manufacturer waives any responsibility arisen from incorrect usage or transportation.

- This appliance is intended to be used in household and similar applications such as:
 - staff kitchen areas in shops, offices and other working environments;
 - farm houses;
 - by clients in hotels, motels and other residential type environments;
 - bed and breakfast type environments;
 - areas for communal use in blocks of flats or in launderettes.

Children's safety

- Packaging materials are dangerous to children. Keep packaging materials in a safe place away from reach of the children.
- Electrical products are dangerous to children. Keep children away from the product when it is in use. Do not let them to tamper with the product. Use child lock to prevent children from intervening with the product.
- Do not forget to close the loading door when leaving the room where the product is located.
- Store all detergents and additives in a safe place away from the reach of the children by closing the cover of the detergent container or sealing the detergent package.



While washing the laundry at high temperatures, the loading door glass becomes hot. Therefore, keep children away from the loading door of the machine while the washing operation is in progress.

Compliance with the WEEE Directive



This product complies with EU WEEE Directive (2012/19/EU). This product bears a classification symbol for waste electrical and electronic equipment (WEEE).



This product has been manufactured with high quality parts and materials which can be reused and are suitable for recycling. Do not dispose of the waste product with normal domestic and other wastes at the end of its service life. Take it to the collection center for the recycling of electrical and electronic equipment. Please consult your local authorities to learn about these collection centers.

Compliance with RoHS Directive:

The product you have purchased complies with EU RoHS Directive (2011/65/EU). It does not contain harmful and prohibited materials specified in the Directive.

Package information

- Packaging materials of the product are manufactured from recyclable materials in accordance with our National Environment Regulations. Do not dispose of the packaging materials together with the domestic or other wastes. Take them to the packaging material collection points designated by the local authorities.

Your washing machine

Overview

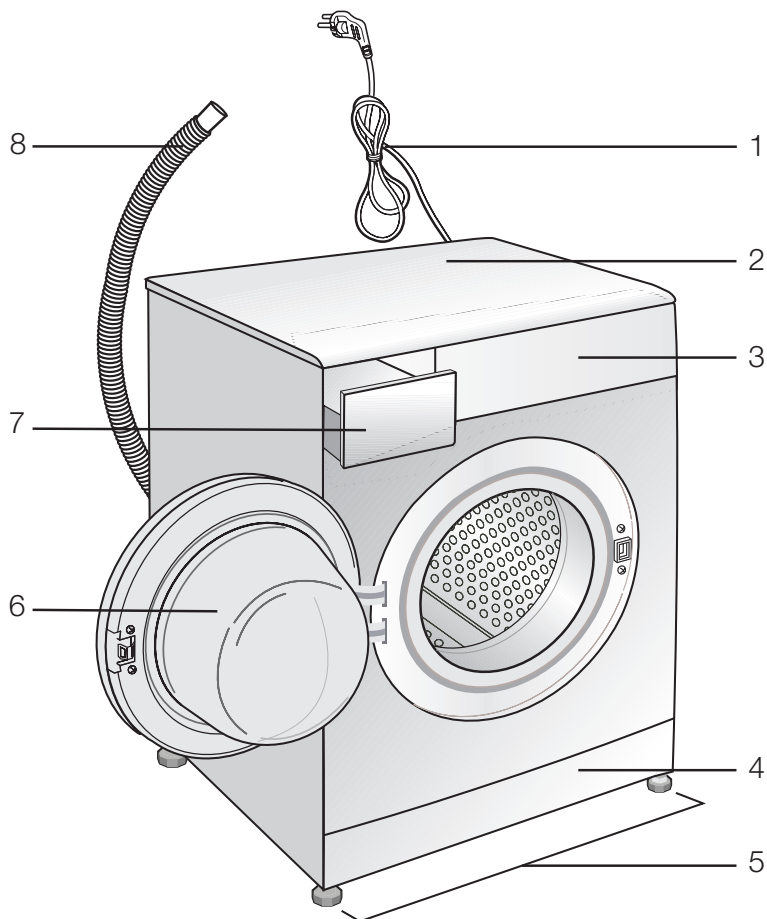

- 1- Power cable
- 2- Top panel
- 3- Control panel
- 4- Filter cap
- 5- Adjustable feet
- 6- Loading door
- 7- Detergent drawer
- 8- Drain hose

Package Contents

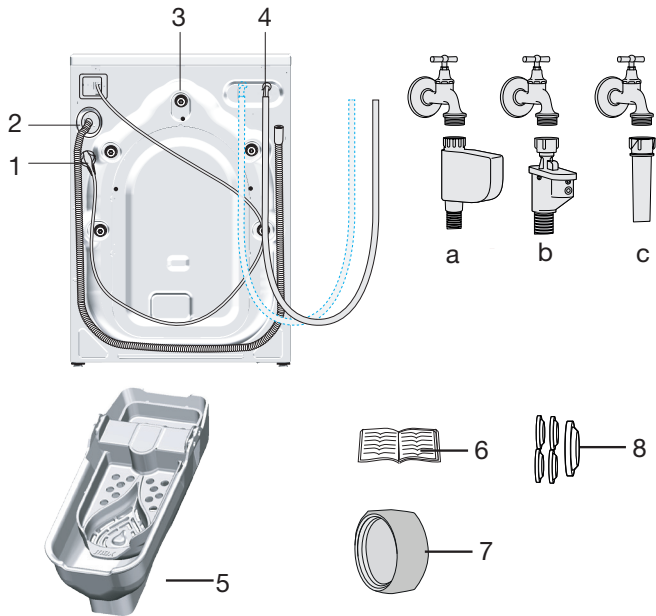

- 1- Power cable
- 2- Drain hose
- 3- Transportation safety bolts *
- 4- Mains water inlet hose (One of the following filter types is used for the mains hose connection.)
 - a- Electronic water shut-off
 - b- Mechanical water shut-off
 - c- Standard
- 5- Liquid detergent container**
- 6- User Manual
- 7- Blind plug***
- 8- Plastic plug group

* Number of transportation safety bolts may change depending on the model of your machine.
** This may be supplied with the machine depending on the model of your machine.
*** This is supplied if your machine is equipped with double water inlet.

Technical specifications

Complying Commission Delegated Regulation (EU) No 1061/2010

Supplier name or trademark	GRUNDIG
Model name	GWN 37430
Rated capacity (kg)	7
Energy efficiency class / Scale from A+++ (Highest Efficiency) to D (Lowest Efficiency)	A+++
Annual Energy Consumption (kWh) ⁽¹⁾	168
Energy consumption of the standard 60°C cotton programme at full load (kWh)	0.782
Energy consumption of the standard 60°C cotton programme at partial load (kWh)	0.748
Energy consumption of the standard 40°C cotton programme at partial load (kWh)	0.688
Power consumption in 'off-mode' (W)	0.500
Power consumption in 'left-on mode' (W)	0.500
Annual Water Consumption (l) ⁽²⁾	11220
Spin-drying efficiency class / Scale from A (Highest Efficiency) to G (Lowest Efficiency)	B
Maximum spin speed (rpm)	1400
Remaining moisture Content (%)	53
Standard cotton programme ⁽³⁾	Cotton Eco 60°C and 40°C
Programme time of the standard 60°C cotton programme at full load (min)	234
Programme time of the standard 60°C cotton programme at partial load (min)	175
Programme time of the standard 40°C cotton programme at partial load (min)	175
Duration of the left-on mode (min)	N/A
Airborne acoustical noise emissions washing/spinning (dB)	51/75
Built-in	No
Height (cm)	84
Width (cm)	60
Depth (cm)	55
Net weight (±4 kg.)	70
Single Water inlet / Double Water inlet	• / -
• Available	
Electrical input (V/Hz)	230 V / 50Hz
Total current (A)	10
Total power (W)	2200
Main model code	9811

⁽¹⁾ Energy Consumption based on 220 standard washing cycles for cotton programmes at 60°C and 40°C at full and partial load, and the consumption of the low-power modes. Actual energy consumption will depend on how the appliance is used.





⁽²⁾ Water consumption based on 220 standard washing cycles for cotton programmes at 60°C and 40°C at full and partial load. Actual water consumption will depend on how the appliance is used.

⁽³⁾ „Standard 60°C cotton programme“ and the „standard 40°C cotton programme“ are the standard washing programmes to which the information in the label and the fiche relates and these programmes are suitable to clean normally soiled cotton laundry and that they are the most efficient programmes in terms of combined energy and water consumption.

Technical specifications may be changed without prior notice to improve the quality of the product.

Installation

Refer to the nearest Authorised Service Agent for installation of the product. To make the product ready for use, review the information in the user manual and make sure that the electricity, tap water supply and water drainage systems are appropriate before calling the Authorized Service Agent. If they are not, call a qualified technician and plumber to have any necessary arrangements carried out.

	Preparation of the location and electrical, tap water and waste water installations at the place of installation is under customer's responsibility.
	WARNING: Installation and electrical connections of the product must be carried out by the Authorized Service Agent. Manufacturer shall not be held liable for damages that may arise from procedures carried out by unauthorized persons.
	WARNING: Prior to installation, visually check if the product has any defects on it. If so, do not have it installed. Damaged products cause risks for your safety.
	Make sure that the water inlet and discharge hoses as well as the power cable are not folded, pinched or crushed while pushing the product into its place after installation or cleaning procedures.

Appropriate installation location

- Place the machine on a rigid floor. Do not place it on a long pile rug or similar surfaces.
- Total weight of the washing machine and the dryer -with full load- when they are placed on top of each other reaches to approx. 180 kilograms. Place the product on a solid and flat floor that has sufficient load carrying capacity!
- Do not place the product on the power cable.
- Do not install the product at places where temperature may fall below 0°C.
- Leaving a gap at the sides of the machine is suggested to reduce vibration and noise

- Do not place heat sources such as Hobs, Irons, Ovens, etc. on the washing machine and do not use them on the product.

Removing packaging reinforcement

Tilt the machine backwards to remove the packaging reinforcement. Remove the packaging reinforcement by pulling the ribbon.



Removing the transportation locks



WARNING: Do not remove the transportation locks before taking out the packaging reinforcement.



WARNING: Remove the transportation safety bolts before operating the washing machine! Otherwise, the product will be damaged.

- Loosen all the bolts with a suitable spanner until they rotate freely.

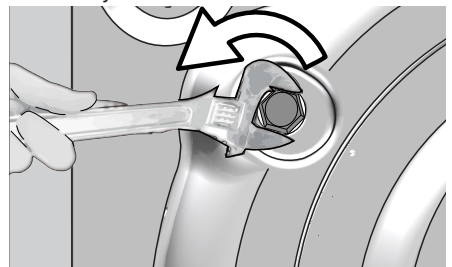

- Remove transportation safety bolts by turning them gently.

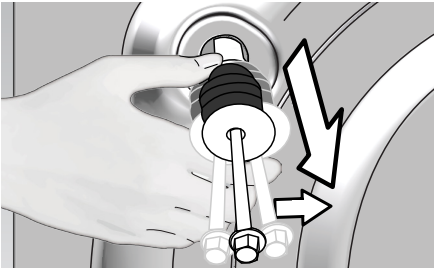

- Attach the plastic covers supplied in the User Manual bag into the holes on the rear panel.

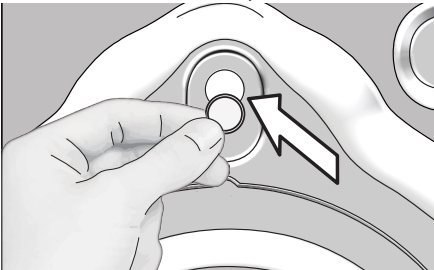

Keep the transportation safety bolts in a safe place to reuse when the washing machine needs to be moved again in the future.

Never move the product without the transportation safety bolts properly fixed in place!

- Tighten all hose nuts by hand. Never use a tool when tightening the nuts.

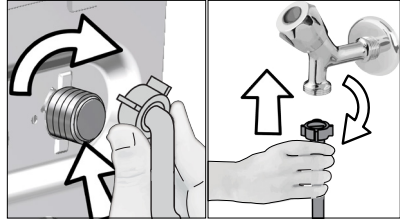

- Open the taps completely after making the hose connection to check for water leaks at the connection points. If any leaks occur, turn off the tap and remove the nut. Retighten the nut carefully after checking the seal. To prevent water leakages and damages caused by them, keep the taps closed when the machine is not in use.

Connecting to the drain

- The end of the drain hose must be directly connected to the wastewater drain or to the washbasin.



WARNING: Your house will be flooded if the hose comes out of its housing during water discharge. Moreover, there is risk of scalding due to high washing temperatures! To prevent such situations and to ensure smooth water intake and discharge of the machine, fix the end of the discharge hose tightly so that it cannot come out.

- The hose should be attached to a height of at least 40 cm, and 100 cm at most.
- In case the hose is elevated after laying it on the floor level or close to the ground (less than 40 cm above the ground), water discharge becomes more difficult and the laundry may come out excessively wet. Therefore, follow the heights described in the figure.

Connecting water supply



The water supply pressure required to run the product is between 1 to 10 bars (0.1 – 1 MPa). It is necessary to have 10 – 80 liters of water flowing from the fully open tap in one minute to have your machine run smoothly. Attach a pressure reducing valve if water pressure is higher.



WARNING: Models with a single water inlet should not be connected to the hot water tap. In such a case the laundry will get damaged or the product will switch to protection mode and will not operate.



WARNING: Do not use old or used water inlet hoses on the new product. It may cause stains on your laundry.

Adjusting the feet

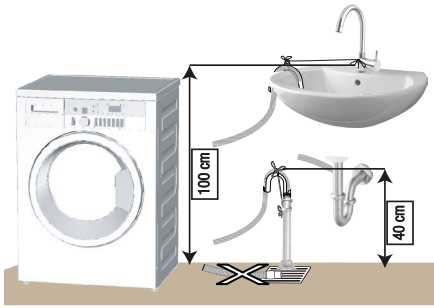

- To prevent flowing of dirty water back into the machine and to allow for easy discharge, do not immerse the hose end into the dirty water or do not drive it in the drain more than 15 cm. If it is too long, cut it short.
- The end of the hose should not be bent, it should not be stepped on and the hose must not be pinched between the drain and the machine.
- If the length of the hose is too short, use it by adding an original extension hose. Length of the hose may not be longer than 3.2 m. To avoid water leak failures, the connection between the extension hose and the drain hose of the product must be fitted well with an appropriate clamp as not to come off and leak.



WARNING: In order to ensure that the product operates more silently and vibration-free, it must stand level and balanced on its feet. Balance the machine by adjusting the feet. Otherwise, the product may move from its place and cause crushing and vibration problems.

- Loosen the lock nuts on the feet by hand.

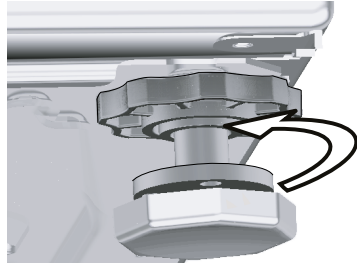

- Adjust the feet until the product stands level and balanced.

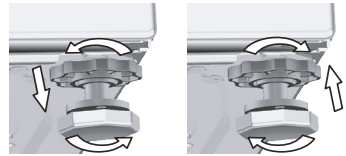

- Tighten all lock nuts again by hand.

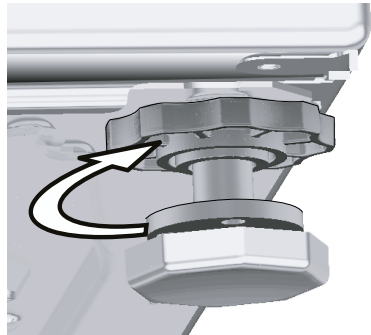

WARNING: Do not use any tools to loosen the lock nuts. Otherwise, they will get damaged.

Electrical connection

Connect the product to a grounded outlet protected by a 16 A fuse. Our company shall not be liable for any damages that will arise when the product is used without grounding in accordance with the local regulations.

- Connection must comply with national regulations.
- The wiring for the electrical outlet circuit must be sufficient to meet the appliance requirements. Use of a Ground Fault Circuit Interrupter (GFCI) is recommended.
- Power cable plug must be within easy reach after installation.
- If the current value of the fuse or breaker in the house is less than 16 Amps, have a qualified electrician install a 16 Amp fuse.
- The voltage specified in the "Technical specifications" section must be equal to your mains voltage.
- Do not make connections via extension cables or multi-plugs.



WARNING: Damaged power cables must be replaced by the Authorized Service Agents.

Transportation of the product

- Unplug the product before transporting it.
- Remove water drain and water supply connections.
- Drain all water that has remained in the product.
- Install transportation safety bolts in the reverse order of removal procedure; .



Never move the product without the transportation safety bolts properly fixed in place!





























WARNING: Packaging materials are dangerous to children. Keep packaging materials in a safe place away from reach of the children.

Preparation

Sorting the laundry

- Sort laundry according to type of fabric, colour, and degree of soiling and allowable water temperature.
- Always obey the instructions given on the garment tags.

LAUNDRY WASH SYMBOLS											
 Machine Wash Symbols	 Normal wash	 No Iron	 Sensitive-Delicate wash	 Hand wash	 Not washable	 No Spin					
							WASH	Water Temperatures	Maximum Symbol(s)	95°C ●●●	70°C ●●●
 Drying Symbols	 Suitable for dryer	 No Iron	 Sensitive / Delicate dry	 Do not dry with dryer	 Do not dry	 Do not dry-clean					
							DRYING	Drying Settings	 At any temperature	 At high temperature	 At medium temperature
 IRON	Iron -		 Iron at high temperature	 Iron at medium temperature	 Iron at low temperature	 Do not iron	 Iron without steam				
	Dry or Steam		200 °C	150 °C	110 °C						
BLEACH	 All bleaches are allowed		 Bleach (sodium hypochlorite) can be used		 Bleach is not allowed		 Only bleaches without chlorine are allowed				

Preparing laundry for washing

- Laundry items with metal attachments such as, underwired bras, belt buckles or metal buttons will damage the machine. Remove the metal pieces or wash the clothes by putting them in a laundry bag or pillow case.
- Take out all items in the pockets such as coins, pens and paper clips, and turn pockets inside out and brush. Such objects may damage the product or cause noise problem.
- Put small size clothes such as infant's socks and nylon stockings in a laundry bag or pillow case.
- Place curtains in without compressing them. Remove curtain attachment items.
- Fasten zippers, sew loose buttons and mend rips and tears.
- Wash "machine washable" or "hand washable" labelled products only with an appropriate programme.
- Do not wash colours and whites together. New, dark coloured cottons release a lot of dye. Wash them separately.
- Tough stains must be treated properly before washing. If unsure, check with a dry cleaner.
- Use only dyes/colour changers and limescale removers suitable for machine wash. Always follow the instructions on the package.
- Wash trousers and delicate laundry turned inside out.
- Keep laundry items made of Angora wool in the freezer for a few hours before washing. This will reduce pilling.
- Laundry that are subjected to materials such as flour, lime dust, milk powder, etc. intensely must be shaken off before placing into the machine. Such dusts and powders on the laundry may build up on the inner parts of the machine in time and can cause damage.

Things to be done for energy saving

Following information will help you use the product in an ecological and energy-efficient manner.

- Operate the product in the highest capacity allowed by the programme you have selected, but do not overload; , "Programme and consumption table".
- Always follow the instructions on the detergent packaging.
- Wash slightly soiled laundry at low temperatures.
- Use faster programmes for small quantities of lightly soiled laundry.
- Do not use prewash and high temperatures for laundry that is not heavily soiled or stained.
- If you plan to dry your laundry in a dryer, select the highest spin speed recommended during washing process.
- Do not use detergent in excess of the amount recommended on the detergent package.

Initial use

Before starting to use the product, make sure that all preparations are completed in accordance with the instructions in sections "Important safety and environment instructions" and "Installation".

To prepare the product for washing laundry, perform first operation in Drum Cleaning programme. If your machine is not featured with this programme, apply the method described in .



Use an anti-limescale suitable for the washing machines.

Some water might have remained in the product due to the quality control processes in the production. It is not harmful for the product.

Correct load capacity

The maximum load capacity depends on the type of laundry, the degree of soiling and the washing programme desired.

The machine automatically adjusts the amount of water according to the weight of the loaded laundry.



WARNING: Follow the information in the "Programme and consumption table". When overloaded, machine's washing performance will drop. Moreover, noise and vibration problems may occur.

Laundry type	Weight (g)
Bathrobe	1200
Napkin	100
Duvet cover	700
Bed Sheet	500
Pillowcase	200
Tablecloth	250
Towel	200
Hand towel	100
Evening gown	200
Underclothing	100
Men's overalls	600
Men's shirt	200
Men's pyjamas	500
Blouses	100

Loading the laundry

- Open the loading door.
- Place laundry items loosely into the machine.
- Push the loading door to close until you hear a locking sound. Ensure that no items are caught in the door.



The loading door is locked while a programme is running. The door can only be opened a while after the programme comes to an end.



WARNING: In case of misplacing the laundry, noise and vibration problems may occur in the machine.

Using detergent and softener



When using detergent, softener, starch, fabric dye, bleach or limescale remover, read the manufacturer's instructions on the package carefully and follow the suggested dosage values. Use measuring cup if available.

Detergent Drawer

The detergent drawer is composed of three compartments:

- (1) for prewash
- (2) for main wash
- (3) for softener
- (*) in addition, there is siphon piece in the softener compartment.

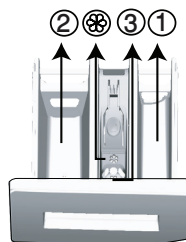

Detergent, softener and other cleaning agents

- Add detergent and softener before starting the washing programme.
- Never leave the detergent drawer open while the washing programme is running!
- When using a programme without prewash, do not put any detergent into the prewash compartment (compartment nr. „1“).
- In a programme with prewash, do not put liquid detergent into the prewash compartment (compartment nr. „1“).
- Do not select a programme with prewash if you are using a detergent bag or dispensing ball. Place the detergent bag or the dispensing ball directly among the laundry in the machine.
- If you are using liquid detergent, do not forget to place the liquid detergent cup into the main wash compartment (compartment nr. „2“).

Choosing the detergent type

The type of detergent to be used depends on the type and colour of the fabric.

- Use different detergents for coloured and white laundry.
- Wash your delicate clothes only with special detergents (liquid detergent, wool shampoo, etc.) used solely for delicate clothes.
- When washing dark coloured clothes and quilts, it is recommended to use liquid detergent.
- Wash woollens with special detergent made specifically for woollens.



WARNING: Use only detergents manufactured specifically for washing machines.



WARNING: Do not use soap powder.

Adjusting detergent amount

The amount of washing detergent to be used depends on the amount of laundry, the degree of soiling and water hardness.

- Do not use amounts exceeding the dosage quantities recommended on the detergent package to avoid problems of excessive foam, poor rinsing, financial savings and finally, environmental protection.
- Use lesser detergent for small amounts or lightly soiled clothes.

Using softeners

Pour the softener into the softener compartment of the detergent drawer.

- Do not exceed the (>max<) level marking in the softener compartment.
- If the softener has lost its fluidity, dilute it with water before putting it in the detergent drawer.

Using liquid detergents

If the product contains a liquid detergent cup:

- Place the liquid detergent cup in compartment nr. „2“.

- If the liquid detergent has lost its fluidity, dilute it with water before putting in the detergent cup.

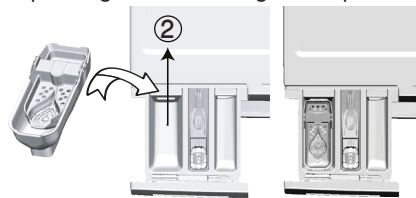

If the product does not contain a liquid detergent cup:

- Do not use liquid detergent for the prewash in a programme with prewash.
- Liquid detergent stains your clothes when used with Delayed Start function. If you are going to use the Delayed Start function, do not use liquid detergent.

Using gel and tablet detergent

- If the gel detergent thickness is fluidal and your machine does not contain a special liquid detergent cup, put the gel detergent into the main wash detergent compartment during first water intake. If your machine contains a liquid detergent cup, fill the detergent into this cup before starting the programme.
- If the gel detergent thickness is not fluidal or in the shape of capsule liquid tablet, put it directly into the drum before washing.
- Put tablet detergents into the main wash compartment (compartment nr. „2“) or directly into the drum before washing.



Tablet detergents may leave residues in the detergent compartment. If you encounter such a case, place the tablet detergent between the laundry, close to the lower part of the drum in future washings.



Use the tablet or gel detergent without selecting the prewash function.

Using starch

- Add liquid starch, powder starch or the fabric dye into the softener compartment.
- Do not use softener and starch together in a washing cycle.
- Wipe the inside of the machine with a damp and clean cloth after using starch.

Using bleaches

- Select a programme with prewash and add the bleaching agent at the beginning of the prewash. Do not put detergent in the prewash compartment. As an alternative application, select a programme with extra rinse and add the bleaching agent while the machine is taking water from the detergent compartment during first rinsing step.
- Do not use bleaching agent and detergent by mixing them.
- Use just a little amount (approx. 50 ml) of bleaching agent and rinse the clothes very well as it causes skin irritation. Do not pour the bleaching agent onto the clothes and do not use it for coloured clothes.
- When using oxygen based bleaches, select a programme that washes at a lower temperature.
- Oxygen based bleaches can be used together with detergents; however, if its thickness is not the same with the detergent, put the detergent first into the compartment nr. „2“ in the detergent drawer and wait until the detergent flows while the machine is taking in water. Add the bleaching agent from the same compartment while the machine is still taking in water.

Using limescale remover

- When required, use limescale removers manufactured specifically for washing machines only.

Tips for efficient washing

		Clothes
		Light colours and whites (Recommended temperature range based on soiling level: 40-90 °C)
Soiling Level	Heavily Soiled (difficult stains such as grass, coffee, fruits and blood.)	It may be necessary to pre-treat the stains or perform prewash. Powder and liquid detergents recommended for whites can be used at dosages recommended for heavily soiled clothes. It is recommended to use powder detergents to clean clay and soil stains and the stains that are sensitive to bleaches.
	Normally Soiled (For example, stains caused by body on collars and cuffs)	Powder and liquid detergents recommended for whites can be used at dosages recommended for normally soiled clothes.
	Lightly Soiled (No visible stains exist.)	Powder and liquid detergents recommended for whites can be used at dosages recommended for lightly soiled clothes.
		Colours
		(Recommended temperature range based on soiling level: cold -40 °C)
Soiling Level	Heavily Soiled	Powder and liquid detergents recommended for colors can be used at dosages recommended for heavily soiled clothes. It is recommended to use powder detergents to clean clay and soil stains and the stains that are sensitive to bleaches. Detergents which do not contain bleach should be used.
	Normally Soiled	Powder and liquid detergents recommended for colors can be used at dosages recommended for normally soiled clothes. Detergents which do not contain bleach should be used.
	Lightly Soiled	Powder and liquid detergents recommended for colors can be used at dosages recommended for lightly soiled clothes. Detergents which do not contain bleach should be used.

Clothes		
Dark colours		
(Recommended temperature range based on soiling level: cold -40 °C)		
Soiling Level	Heavily Soiled	Liquid detergents suitable for colors and dark colors can be used at dosages recommended for heavily soiled clothes.
	Normally Soiled	Liquid detergents suitable for colors and dark colors can be used at dosages recommended for normally soiled clothes.
	Lightly Soiled	Liquid detergents suitable for colors and dark colors can be used at dosages recommended for lightly soiled clothes.
Delicates/Woolens/Silks		
(Recommended temperature range based on soiling level: cold -30 °C)		
Soiling Level	Heavily Soiled	Prefer liquid detergents produced for delicate clothes. Woolen and silk clothes must be washed with special woolen detergents.
	Normally Soiled	Prefer liquid detergents produced for delicate clothes. Woollen and silk clothes must be washed with special woollen detergents.
	Lightly Soiled	Prefer liquid detergents produced for delicate clothes. Woolen and silk clothes must be washed with special woolen detergents.

Operation

Control panel

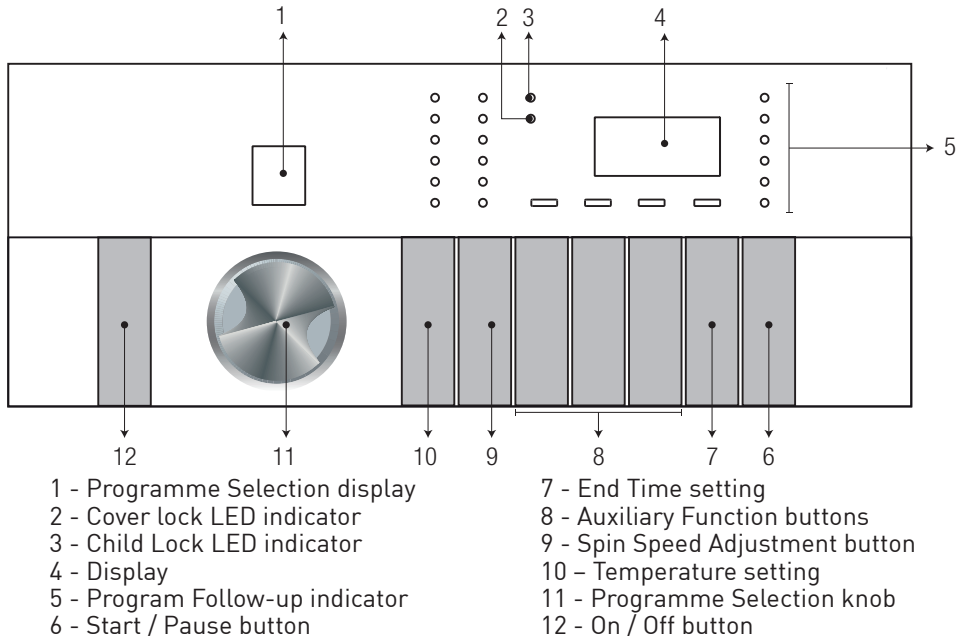

Preparing the machine

- Check that the hoses are connected tightly.
- Plug in your machine.
- Turn the tap on completely.
- Place the laundry in the machine.
- Add detergent and fabric softener.

Programme selection

- Select a suitable programme from "Programme and Consumption Table" (see the Temperature table below). Consider the washing type, washing quantity and degree of soiling.

90 °C	Heavily soiled white cottons and linens. (coffee table covers, tablecloths, towels, bed sheets, etc.)
60 °C	Normally soiled, coloured, fade proof linens, cottons or synthetic clothes (shirt, nightgown, pajamas, etc.) and lightly soiled white linens (underwear, etc.)
40°C 30 °C - Cold	Blended laundry including delicate textile (veil curtains, etc.), synthetics and woolens.

- Select the desired programme with the **Programme Selection** knob.



Programmes are limited with the highest spin speed appropriate for that particular type of fabric.

When selecting a programme, always consider the type of fabric, colour, degree of soiling and permissible water temperature.

Always select the lowest appropriate temperature. Higher temperature means higher electricity consumption.

Programmes

• Cottons

Use this programme for your cotton laundry (such as bed sheets, duvet and pillowcase sets, towels, bathrobes, underwear, etc.). Your laundry will be washed with vigorous washing action for a longer washing cycle.

• Synthetics

Use to wash your synthetic clothes (shirts, blouses, synthetic/cotton blends, etc.). It washes with a gentle action and has a shorter washing cycle compared to the Cottons programme. For curtains and tulle, use the Synthetics 40°C programme with prewash and anti-creasing functions selected. As their meshed texture causes excessive foaming, wash the veils/tulle by putting little amount of detergent into the main wash compartment. Do not put detergent in the prewash compartment.

• WoolProtect

Use to wash your woolen laundry. Select the appropriate temperature complying with the care labels of your clothes. Use appropriate detergents for woollens.

• Cotton Eco

Use to wash your normally soiled, durable cotton and linen laundry. Although it washes longer than all other washing programmes, this programme ensures high power and water saving. Actual water temperature may be different from the specified wash temperature. When you load the machine with less laundry (e.g. ½ capacity or less), programme time may automatically get shorter. In this case, energy and water consumption will decrease further, providing a more economic wash. This programme is available in the models with the remaining time indicator.

• GentleCare

Use this programme to wash your delicate clothes. It washes with a gentle action without any interim spin compared to the Synthetics programme.

• HygieneCare

This is a long lasting programme which you may use for your laundry for which you require an anti-allergic and hygienic washing at high temperature with intensive and long washing cycle.

• Delicate

Use this programme to wash your delicate clothes. It washes with a gentle action without any interim spin compared to the Synthetics programme.

• Hand Wash

Use this programme to wash your woollen/delicate clothes that bear “not machine-washable” tags and for which hand wash is recommended. It washes laundry with a very gentle washing action to not to damage clothes.

• Mini 14'

Use to wash your lightly soiled and unstained cotton laundry in a short time.

• Mini

Use this programme to wash your lightly soiled cotton clothes in a short time.

• Dark Care

Use this programme to wash your dark coloured **cotton and synthetic** laundry or the laundry that you do not want it get faded. Washing is performed with gentle actions and at low temperatures. It is recommended to use liquid detergent or woolen shampoo for dark coloured laundry.

• Shirts

Use this programme to wash the cotton, synthetic and synthetic blended shirts together.

- **AquaPerfect 40° / 40'**

Use to wash your lightly soiled and unstained cotton laundry in a short time.

- **MachineCare**

Use regularly (once in every 1-2 months) to clean the drum and provide the required hygiene. Apply this procedure without any laundry in the product. To obtain better results, put powder limescale remover for washing machines into the detergent compartment "2". When the programme is over, leave the loading door ajar so that the inside of the machine gets dry.



This is a maintenance programme, not a washing programme.

Do not run the programme when there is something in the machine. If you try to do so, the machine detects that there is a load inside and aborts the programme.

Special programmes

For specific applications, select any of the following programmes.

- **Rinsing**

Use when you want to rinse or starch separately.

- **Spin+Pump**

Use this programme to discharge the water in the machine.

Temperature selection

Whenever a new programme is selected, the recommended temperature for the selected programme appears on the temperature indicator.

To decrease the temperature, press the Temperature Adjustment button. Temperature will decrease gradually.



If the programme has not reached the heating step yet, you can change the temperature without switching the machine to Pause mode.

Selecting the spin speed

Whenever a new programme is selected, the recommended spin speed of the selected programme is displayed on the Spin Speed indicator.

To decrease the spin speed, press the Spin Speed Adjustment button. Spin speed decreases gradually. Then, depending on the model of the product, "Rinse Hold" and "No Spin" options appear on the display. See "Auxiliary function selection" section for explanations of these options.

Rinse Hold

If you are not going to unload your clothes immediately after the programme completes, you can use Rinse Hold function to keep your laundry in the final rinsing water in order to prevent them from getting wrinkled when there is no water in the machine. Press Start / Pause button after this process if you want to drain the water without spinning your laundry. Programme will resume and complete after draining the water. If you want to spin the laundry held in water, adjust the Spin Speed and press Start / Pause button.

Program resumes. Water is drained, laundry is spun and the programme is completed.



If the programme has not reached the spinning step yet, you can change the speed without switching the machine to Pause mode.

Programme and consumption table

EN						Auxiliary functions			
Programme (°C)		Max. Load (kg)	Water Consumption (l)	Energy Consumption (kWh)	Max. Speed***	Prewash	Extra Rinse	Night mode	Selectable temperature range °C
Cottons	90	7	80	2.10	1400	•	•	•	Cold-90
	60	7	78	1.65	1400	•	•	•	Cold-90
	40	7	78	0.90	1400	•	•	•	Cold-90
Cotton Eco	60**	7	52	0.78	1400				Cold-60
	60**	3.5	50.5	0.75	1400				Cold-60
	40**	3.5	50	0.69	1400				Cold-60
HygieneCare	60	7	90	1.98	1400		*		30 - 90
Synthetics	60	3	60	1.10	1200	•	•	•	Cold-60
	40	3	60	0.62	1200	•	•	•	Cold-60
AquaPerfect 40° / 40'	40	7	40	0.50	1400				20 - 40
WoolProtect	40	1.5	48	0.40	1200		•	•	Cold-40
MachineCare	90	-	50	1.75	600				90
Delicate	30	2	48	0.45	1200		•	•	Cold-40
Shirts	60	3.5	62	1.10	800	•	•		Cold-60
Mini	90	7	62	1.95	1400		•	•	Cold-90
	60	7	62	1.10	1400		•	•	Cold-90
	30	7	60	0.25	1400		•	•	Cold-90
Mini 14'	30	2	35	0.10	1400		•	•	Cold-30
Darkcare	40	3	74	0.36	1000	•	*	•	Cold-40
GentleCare	20	2	48	0.30	1200		•	•	Cold-40
Hand wash	30	1	35	0.20	1200				Cold-30



• : Selectable.

* : Automatically selected, no canceling.

** : Energy Label programme (EN 60456 Ed.3)

*** : If maximum spin speed of the machine is lower then this value, you can only select up to the maximum spin speed.

- : See the programme explanation for maximum load.

 ** "Cotton eco 40°C and Cotton eco 60°C are standard programmes." These programmes are known as '40°C cotton standard programme' and '60°C cotton standard programme' and shown on the panel with   symbols.

 The auxiliary functions in the table may vary according to the model of your machine.
 „Water and power consumption may vary from the above table subject to the changes in water pressure, water hardness and temperature, ambient temperature, type and amount of laundry, selection of auxiliary functions and spin speed, and changes in electric voltage.“
 „You can see the washing duration on the display of your machine while selecting a programme. Depending on the amount of laundry you have loaded into your machine, there may be a difference of 1-1.5 hours between the duration shown on the display and the actual duration of the wash cycle. Duration will be automatically updated soon after the washing starts.“
 „Selectability of auxiliary functions might be changed by the manufacturer. New selectabilities might be added or existing ones might be removed.“
 „The spin speed of your machine may vary among the programmes, however this speed cannot exceed the max. spin speed of your machine.“

Indicative values for Synthetics programmes (EN)

	Load (kg)	Water Consumption (l)	Energy Consumption (kWh)	Programme Duration (min) *	Remaining Moisture Content (%) **	Remaining Moisture Content (%) **
					≤ 1000 rpm	> 1000 rpm
Synthetics 60	3	60	1.10	105/135 ^l	45	40
Synthetics 40	3	60	0.62	105/135 ^l	45	40

* You can see the washing time of the programme you have selected on the display of the machine. It is normal that small differences may occur between the time shown on the display and the real washing time.

** Remaining moisture content values may differ according to the selected spin speed.

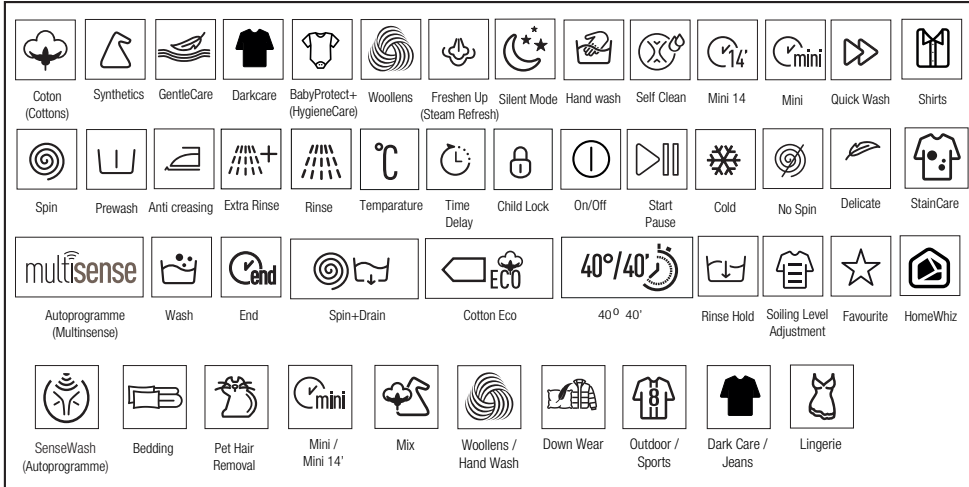

Auxiliary function selection

Select the required auxiliary functions before starting the program. When a programme and the auxiliary function that can be selected together with that programme are selected, the relevant indicator light will illuminate.



Indicator lights of the auxiliary functions that are not allowed to be selected with the current programme will flash and an audio warning is given.

Also, you may select or cancel auxiliary functions suitable for the current programme after the washing has started. If the wash cycle has reached a point where you cannot select the auxiliary function, an audible warning is heard and the indicator light for the relevant auxiliary function flashes.



Some functions cannot be selected together. If a second auxiliary function conflicting with the first one is selected before starting the machine, the function selected first will be cancelled and the second auxiliary function selection will remain active. An example: If "Extra rinse" is selected first, and is then switched to "Quick wash", Extra rinse is then cancelled, the Quick wash remains active.

An auxiliary function that is not compatible with the programme cannot be selected. (See "Programme and consumption table")



Some programmes have auxiliary functions that must be operated simultaneously. Those functions cannot be cancelled. The frame of the auxiliary function will not be illuminated, only inner area will be illuminated.

• Prewash

A Prewash is only worthwhile for heavily soiled laundry. Not using the Prewash will save energy, water, detergent and time.

• Extra Rinse

This function enables the machine to make another rinsing in addition to the one already made after the main wash. Thus, the risk for sensitive skins (babies, allergic skins, etc.) to be effected by the minimal detergent remnants on the laundry can be reduced.

• Night Mode

Use to wash the cottons with lesser energy consumption and silently. Spin steps are cancelled for a silent washing and the cycle ends with the Rinse Hold step. After completion of the programme, run Spin cycle to spin the laundry.

- Press Start / Pause button. Time countdown starts. ":" sign in the middle of the end time on the display starts flashing.



Additional laundry may be loaded during the End Time countdown period. At the end of the countdown, End Time indicator turns off, washing cycle starts and the time of the selected programme appears on the display.

When the End Time selection is completed, the time appears on the screen consists of end time plus the duration of the selected programme.

Changing the End Time duration

Press the End Time button. Every time the button is pressed, the period will change in 3-hour increments and the light of the selected End Time will turn on.

Cancelling the End Time function

If you want to cancel the End Time countdown and start the programme immediately:

- Set the End Time from zero (delete all end time displays) or hold down the On/Off button for 3 seconds. The End Time is cancelled when the machine is turned off and on again.
- Then, select the programme you want to run again.
- Start the programme with the Start/Pause button.

End Time

With the End Time function, the startup of the programme may be delayed up to 24 hours. After pressing End Time button, the programme's estimated ending time is displayed. If the End Time is adjusted, End Time indicator is illuminated.

In order for the End Time function to be activated and the programme to be completed at the end of the specified time, you must press Start / Pause button after adjusting the time.

If you want to cancel End Time function, press On / Off button to turn off and on the machine.



Do not use liquid detergents when you activate End Time function! There is the risk of staining of the clothes.

- Open the loading door, place the laundry and put detergent, etc.
- Select the washing programme, temperature, spin speed and, if required, the auxiliary functions.
- Set the end time of your choice by pressing the End Time button. End Time indicator illuminates.

Starting the programme

- Start the programme with the Start/Pause button.
- Programme follow-up light showing the startup of the programme will turn on.



Machine returns to OFF mode when no programme is started or no button is pressed in 10 minutes during the programme selection. Display and all indicators are turned off.

When you press On/Off button, information about the selected programme is displayed.

Door lock

There is a locking system on the loading door of the machine that prevents opening of the door in cases when the water level is unsuitable. "Door Locked" LED in the panel turns on when the loading door is locked.

Changes after programme has started

Adding laundry after the programme has started:

Stopping the machine (pause)

Press the Start/Pause button to switch the machine to pause mode while a programme is running. The Start/Pause and the light for the step which the machine is in start flashing in the programme follow-up indicator to show that the machine has been switched to the pause mode. Also, the loading door light flashes until it is possible to open the door. Loading Door light shall be turned off once the loading door is ready to be opened, but the programme step light and Start/Pause light continue to flash.

Also, when the loading door is ready to be opened, Loading Door light will also turn off in addition to the programme step light.

Changing the auxiliary function, speed and temperature

Depending on the step the programme has reached, you can cancel or activate the auxiliary functions; see, "Auxiliary function selection".

You may also change the speed and temperature settings; see, "Spin speed selection" and "Temperature selection".



If no change is allowed, the relevant light will flash for 3 times.

Adding or taking out laundry

- Press the Start / Pause button to pause the machine. The programme follow-up light of the relevant step during which the machine was switched into the pause mode will flash.
- Wait until the Loading Door can be opened.
- Open the Loading Door and add or take out the laundry.
- Close the Loading Door.
- Make changes in auxiliary functions, temperature and speed settings if necessary.
- Press Start/Pause button to start the machine.

Child Lock

With the Child Lock function, you can prevent children from tampering with the machine. Thus you can avoid any changes in a running programme.



You can switch on and off the machine with **On / Off** button when the Child Lock is active. When you switch on the machine again, programme will resume from where it has stopped.

To activate the Child Lock:

Hold down the button for the 1st Auxilliary Function for 3 seconds. "Child Lock Enabled (CL On)" appears on the display after the countdown as "3_2_1" in the programme selection display on the panel. When this warning appears, the **1st Auxilliary Function** button can be released.

To deactivate the Child Lock:

Hold down the button for the 1st Auxilliary Function for 3 seconds. After the countdown as "3_2_1" on the programme selection display on the panel is over, "Child Lock Enabled (CL Off)" symbol turns off.

labelling Cancellng the programme

The programme is cancelled when the machine is turned off and on again. Press and hold **On / Off** button for 3 seconds.



If you press **On/Off** button when the Child Lock is enabled, the programme will not be cancelled. You should cancel the Child Lock first.



If you want to open the loading door after you have cancelled the programme but it is not possible to open the loading door since the water level in the machine is above the loading door opening, then turn the **Programme Selection** knob to **Spin + Drain** programme and discharge the water in the machine.

labelling End of programme

Once the programme is completed, End LED will light up.

If you do not press any button for 10 minutes, the machine will switch to OFF mode. Display and all indicators are turned off.

When you press On/Off button, the completed programme steps will be displayed.

labelling Setting volume level

labelling Low volume and high volume

To modify the volume, hold down the 2nd Additional Function button for 3 seconds.

labelling Your machine is equipped with a "Standby Mode"

In case of not starting any programme or waiting without making any other operation while the machine is in the selection step after it is turned on by On/Off button or if no other operation is performed approximately 10 minutes after the programme you selected has come to an end, your machine will switch to OFF mode. Display and all indicators are turned off. When you press On/Off button, information about the selected programme is displayed. Please check the correctness of your selections before starting the programme. Readjust if necessary. This is not a failure.

Quick User Guide

Preparing the machine

- Check if the hoses are connected tightly.
- Plug in your machine.
- Turn the tap on completely.
- Place the laundry in the machine.
- Add detergent and fabric softener.

Programme selection

- Select the programme suitable for the type, quantity and soiling level of the laundry in accordance with the "Programme and consumption table" and the temperature table.

Auxiliary function selection

Select the required auxiliary functions before starting the program. Whenever a programme is selected, frames of the auxiliary function symbols that can be selected together with it illuminate. When an auxiliary function is selected, the inner section will illuminate as well.

Starting the programme

- Press Start / Pause button to start the programme.
- Programme follow-up light showing the startup of the programme will turn on.



If no programme is started or no key is pressed within 1 minute during programme selection process, the machine will switch to Pause mode and the illumination level of the temperature, speed and loading door indicator lights will decrease. Other indicator lights and indicators will turn off. Once the Programme Selection knob is rotated or any button is pressed, indicator lights and indicators will turn on again.

End of programme

When the programme completes, End symbol will be displayed.

If you do not press any button for 10 minutes, the machine will switch to OFF mode. Display and all indicators are turned off.

When you press On/Off button, the completed programme steps will be displayed.

Cancelling the programme

The programme is cancelled when the machine is turned off and on again. Press and hold **On / Off** button for 3 seconds.

Child Lock

Use Child Lock function to prevent children from tampering with the machine. Thus you can avoid any changes in a running programme.



You can switch on and off the machine with **On / Off** button when the Child Lock is active. When you switch on the machine again, programme will resume from where it has stopped.

To activate the Child Lock:

* **Press and hold** 1st Auxiliary Function button for 3 seconds. "3-2-1 CL On" appears on the display after the countdown on the panel. You can release the **1st Auxiliary Function** button when this warning is displayed.

To deactivate the Child Lock:

keep the **1st auxiliary function** button pressed for 3 seconds. After the countdown on the panel is over, "3-2-1 CL On" symbol turns off.

Maintenance and cleaning

Service life of the product extends and frequently faced problems decrease if cleaned at regular intervals.

Cleaning the detergent drawer

Clean the detergent drawer at regular intervals (every 4-5 washing cycles) as shown below in order to prevent accumulation of powder detergent in time.

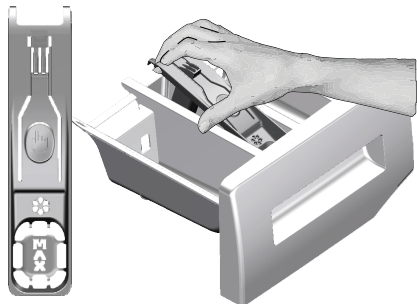

Lift the rear part of the siphon to remove it as illustrated.

- Press the dotted point on the siphon in the softener compartment and pull towards you until the compartment is removed from the machine.



If more than normal amount of water and softener mixture starts to gather in the softener compartment, clean the siphon.

- Wash the detergent drawer and the siphon with plenty of lukewarm water in a washbasin. Wear protective gloves or use an appropriate brush to avoid touching of the residues in the drawer with your skin when cleaning.
- After cleaning, seat the siphon well in its place and insert the drawer back.

Cleaning the loading door and the drum

For products with drum cleaning programme, please see Operating the product - Programmes.



Repeat Drum Cleaning process in every 2 months.

Use an anti-limescale suitable for the washing machines.

After every washing check that no foreign substance is left in the drum.



If the holes on the bellow shown in the figure is blocked, open the holes using a toothpick.



Foreign metal substances will cause rust stains in the drum. Clean the stains on the drum surface by using cleaning agents for stainless steel. Never use steel wool or wire wool.



WARNING: Never use sponge or scrub materials. These will damage the painted, chrome plated and plastic surfaces.

Cleaning the body and control panel

Wipe the body of the machine with soapy water or non-corrosive mild gel detergents as necessary, and dry with a soft cloth.

Use only a soft and damp cloth to clean the control panel.

Cleaning the water intake filters

There is a filter at the end of each water intake valve at the rear of the machine and also at the end of each water intake hose where they are connected to the tap. These filters prevent foreign substances and dirt in the water to enter the washing machine. Filters should be cleaned as they do get dirty.

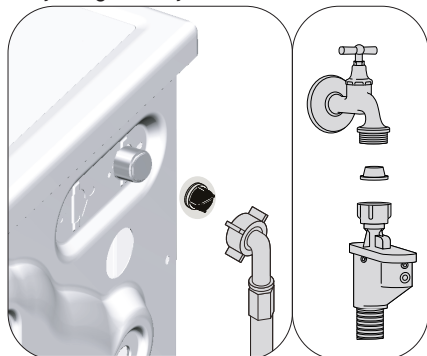

- Close the taps.
- Remove the nuts of the water intake hoses to access the filters on the water intake valves. Clean them with an appropriate brush. If the filters are too dirty, take them out by means of pliers and clean them.
- Take out the filters on the flat ends of the water intake hoses together with the gaskets and clean thoroughly under running water.
- Replace the gaskets and filters carefully in their places and tighten the hose nuts by hand.

Draining remaining water and cleaning the pump filter

The filter system in your machine prevents solid items such as buttons, coins and fabric fibers clogging the pump impeller during discharge of washing water. Thus, the water will be discharged without any problem and the service life of the pump will extend. If the machine fails to drain water, the pump filter is clogged. Filter must be cleaned whenever it is clogged or in every 3 months. Water must be drained off first to clean the pump filter.

In addition, prior to transporting the machine (e.g., when moving to another house) and in case of freezing of the water, water may have to be drained completely.



WARNING: Foreign substances left in the pump filter may damage your machine or may cause noise problem.



WARNING: If the product is not in use, turn the tap off, detach the supply hose and drain the water inside the machine against any freezing possibility in the region of installation.



WARNING: After each use close the supply hose tap of the product.

In order to clean the dirty filter and discharge the water:

- Unplug the machine to cut off the supply power.



WARNING: Temperature of the water inside the machine may rise up to 90 °C. To avoid burning risk, clean the filter after the water in the machine cools down.

- Open the filter cap.
- If the filter cap is composed of two pieces, press the tab on the filter cap downwards and pull the piece out towards yourself.



If the filter cap is one piece, pull the cap from both sides at the top to open.

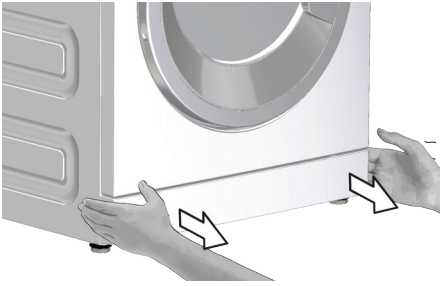

You can remove the filter cover by slightly pushing downwards with a thin plastic tipped tool, through the gap above the filter cover. Do not use metal tipped tools to remove the cover.

- Some of our products have emergency draining hose and some does not have. Follow the steps below to discharge the water.

If the product has an emergency draining hose, to discharge the water:

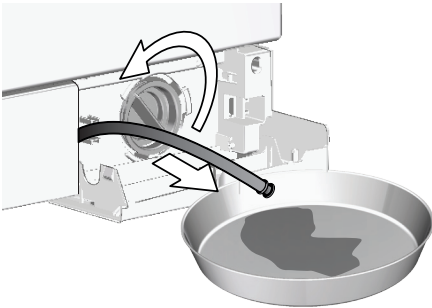

- Pull the emergency draining hose out from its seat
- Place a large container at the end of the hose. Drain the water into the container by pulling out the plug at the end of the hose. When the container is full, block the inlet of the hose by replacing the plug. After the container is emptied, repeat the above procedure to drain the water in the machine completely.

- When draining of water is finished, close the end by the plug again and fix the hose in its place.
- Turn the pump filter to take it out.
- Clean any residues inside the filter as well as fibers, if any, around the pump impeller region.
- Install the filter.
- If the filter cap is composed of two pieces, close the filter cap by pressing on the tab. If it is one piece, seat the tabs in the lower part into their places first, and then press the upper part to close.

Troubleshooting

Program does not start after closing the door.

- Start / Pause / Cancel button was not pressed. >>> **Press the Start / Pause / Cancel button.*
- It may be difficult to close the loading door in case of excessive loading. >>> *Reduce the amount of laundry and make sure that the loading door is closed properly.*

Programme cannot be started or selected.

- Washing machine has switched to self protection mode due to a supply problem (line voltage, water pressure, etc.). >>> *Press and hold On / Off button for 3 seconds to reset the machine to factory settings. ("Cancelling the programme")*

Water in the machine.

- Some water might have remained in the product due to the quality control processes in the production. >>> *This is not a failure; water is not harmful to the machine.*

There is water leaking from the bottom of the machine.

- Likely problems with hoses or the pump filter. >>> *Be sure the seals of the water inlet hoses are securely fitted. Attach the hose to the tap tightly.*
- Pump filter might not be closed fully. >>> *Check if the pump filter is completely closed.*

Machine does not fill with water.

- Tap is turned off. >>> *Open the taps.*
- Water inlet hose is bent. >>> *Correct the hose.*
- Water inlet filter is clogged. >>> *Clean the filter.*
- The loading door is ajar. >>> *Close the loading door.*

Machine does not drain water.

- Water drain hose might be clogged or twisted. >>> *Clean or flatten the hose.*
- Pump filter is clogged. >>> *Clean the pump filter.*

Machine vibrates or makes noise.

- Machine might be standing unbalanced. >>> *Adjust the feet to level the machine.*
- A hard substance might have entered into the pump filter. >>> *Clean the pump filter.*
- Transportation safety bolts are not removed. >>> *Remove the transportation safety bolts.*
- Laundry quantity in the machine might be too little. >>> *Add more laundry to the machine.*
- Machine might be overloaded with laundry. >>> *Take out some of the laundry from the machine or distribute the load by hand to balance it homogenously in the machine.*
- Machine might be leaning on a rigid item. >>> *Check if the machine is not leaning on anything.*

Machine stopped shortly after the programme started.

- Machine might have stopped temporarily due to low voltage. >>> *It will resume running when the voltage restores to the normal level.*

Machine directly discharges the water it takes in.

- Draining hose might not be at adequate height. >>> *Connect the water draining hose as described in the operation manual.*

No water can be seen in the machine during washing.

- The water level is not visible from outside of the washing machine. This is not a failure.

Loading door cannot be opened.

- Door lock is activated because of the water level in the machine. >>> *Drain the water by running the Pump or Spin programme.*
- Machine is heating up the water or it is at the spinning cycle. >>> *Wait until the programme completes.*
- Child lock is engaged. Door lock will be deactivated a couple of minutes after the programme has come to an end. >>> *Wait for a couple of minutes for deactivation of the door lock.*
- Loading door may be stuck because of the pressure it is subjected to. >>> *Grab the handle and push and pull the loading door to release and open it.*

Washing takes longer than the specified in the manual. (*)

- Water pressure is low. >>> *Machine waits until taking in adequate amount of water to prevent poor washing quality due to the decreased amount of water. Therefore, the washing time extends.*
- Voltage might be low. >>> *Washing time is prolonged to avoid poor washing results when the supply voltage is low.*
- Input temperature of water might be low. >>> *Required time to heat up the water extends in cold seasons. Also, washing time can be lengthened to avoid poor washing results.*
- Number of rinses and/or amount of rinse water might have increased. >>> *Machine increases the amount of rinse water when good rinsing is needed and adds an extra rinsing step if necessary.*
- Excessive foam might have occurred and automatic foam absorption system might have been activated due to too much detergent usage. >>> *Use recommended amount of detergent.*

Programme time does not countdown. (On models with display) (*)

- Timer may stop during water intake. >>> *Timer indicator will not countdown until the machine takes in adequate amount of water. The machine will wait until there is sufficient amount of water to avoid poor washing results due to lack of water. Timer indicator will resume countdown after this.*
- Timer may stop during heating step. >>> *Timer indicator will not countdown until the machine reaches the selected temperature.*
- Timer may stop during spinning step. >>> *Automatic unbalanced load detection system might be activated due to the unbalanced distribution of the laundry in the drum.*

Programme time does not countdown. (*)

- There might be an imbalance of laundry in the machine. >>> *Automatic unbalanced load detection system might be activated due to the unbalanced distribution of the laundry in the drum.*

Machine does not switch to spinning step. (*)

- There might be an imbalance of laundry in the machine. >>> *Automatic unbalanced load detection system might be activated due to the unbalanced distribution of the laundry in the drum.*
- The machine will not spin if water is not drained completely. >>> *Check the filter and the draining hose.*
- Excessive foam might have occurred and automatic foam absorption system might have been activated due to too much detergent usage. >>> *Use recommended amount of detergent.*

Washing performance is poor: Laundry turns grey. ()**

- Insufficient amount of detergent was used over a long period of time. >>> *Use the recommended amount of detergent appropriate for water hardness and the laundry.*
- Washing was made at low temperatures for a long time over a long period of time. >>> *Select the proper temperature for the laundry to be washed.*
- Insufficient amount of detergent is used with hard waters. >>> *Using insufficient amount of detergent with hard water causes the soil to stick on the cloth and this turns the cloth into grey in time. It is difficult to eliminate greying once it happens. Use the recommended amount of detergent appropriate for water hardness and the laundry.*
- Too much detergent is used. >>> *Use the recommended amount of detergent appropriate for water hardness and the laundry.*

Washing performance is poor: Stains persist or the laundry is not whitened. ()**

- Insufficient amount of detergent is used. >>> *Use recommended amount of detergent appropriate for the laundry.*
- Excessive laundry was loaded in. >>> *Do not load the machine in excess. Load with amounts recommended in the "Programme and consumption table".*
- Wrong programme and temperature were selected. >>> *Select the proper programme and temperature for the laundry to be washed.*
- Wrong type of detergent is used. >>> *Use original detergent appropriate for the machine.*
- Detergent is put in the wrong compartment. >>> *Put the detergent in the correct compartment. Do not mix the bleaching agent and the detergent with each other.*

Washing performance is poor: Oily stains appeared on the laundry. ()**

- Regular drum cleaning is not applied. >>> *Clean the drum regularly. For this, please .*

Washing performance is poor: Clothes smell unpleasantly. ()**

- Odours and bacteria layers are formed on the drum as a result of continuous washing at lower temperatures and/or in short programmes. >>> *Leave the detergent drawer as well as the loading door of the machine ajar after each washing. Thus, a humid environment favorable for bacteria cannot occur in the machine.*

Colour of the clothes faded. ()**

- Excessive laundry was loaded in. >>> *Do not load the machine in excess.*
- Detergent in use is damp. >>> *Keep detergents closed in an environment free of humidity and do not expose them to excessive temperatures.*
- A higher temperature is selected. >>> *Select the proper programme and temperature according to the type and soiling degree of the laundry.*

It does not rinse well.

- The amount, brand and storage conditions of the detergent used are inappropriate. >>> *Use a detergent appropriate for the washing machine and your laundry. Keep detergents closed in an environment free of humidity and do not expose them to excessive temperatures.*
- Detergent is put in the wrong compartment. >>> *If detergent is put in the prewash compartment although prewash cycle is not selected, machine can take this detergent during rinsing or softener step. Put the detergent in the correct compartment.*
- Pump filter is clogged. >>> *Check the filter.*
- Drain hose is folded. >>> *Check the drain hose.*

Laundry became stiff after washing. ()**

- Insufficient amount of detergent is used. >>> *Using insufficient amount of detergent for the water hardness can cause the laundry to become stiff in time. Use appropriate amount of detergent according to the water hardness.*
- Detergent is put in the wrong compartment. >>> *If detergent is put in the prewash compartment although prewash cycle is not selected, machine can take this detergent during rinsing or softener step. Put the detergent in the correct compartment.*
- Detergent might be mixed with the softener. >>> *Do not mix the softener with detergent. Wash and clean the dispenser with hot water.*

Laundry does not smell like the softener. ()**

- Detergent is put in the wrong compartment. >>> *If detergent is put in the prewash compartment although prewash cycle is not selected, machine can take this detergent during rinsing or softener step. Wash and clean the dispenser with hot water. Put the detergent in the correct compartment.*
- Detergent might be mixed with the softener. >>> *Do not mix the softener with detergent. Wash and clean the dispenser with hot water.*

Detergent residue in the detergent drawer. ()**

- Detergent is put in wet drawer. >>> *Dry the detergent drawer before putting in detergent.*
- Detergent has gotten damp. >>> *Keep detergents closed in an environment free of humidity and do not expose them to excessive temperatures.*
- Water pressure is low. >>> *Check the water pressure.*
- The detergent in the main wash compartment got wet while taking in the prewash water. Holes of the detergent compartment are blocked. >>> *Check the holes and clean if they are clogged.*
- There is a problem with the detergent drawer valves. >>> *Call the Authorised Service Agent.*
- Detergent might be mixed with the softener. >>> *Do not mix the softener with detergent. Wash and clean the dispenser with hot water.*
- Regular drum cleaning is not applied. >>> *Clean the drum regularly. For this, please .*

There is detergent left on the laundry. ()**

- Excessive laundry was loaded in. >>> *Do not load the machine in excess.*
- Wrong programme and temperature were selected. >>> *Select the proper programme and temperature for the laundry to be washed.*
- Wrong detergent was used. >>> *Select the proper detergent for the laundry to be washed.*

Too much foam forms in the machine. (**)

- Improper detergents for the washing machine are being used. >>> *Use detergents appropriate for the washing machine.*
- Excessive amount of detergent is used. >>> *Use only sufficient amount of detergent.*
- Detergent was stored under improper conditions. >>> *Store detergent in a closed and dry location. Do not store in excessively hot places.*
- Some meshed laundry such as tulle may foam too much because of their texture. >>> *Use smaller amounts of detergent for this type of item.*
- Detergent is put in the wrong compartment. >>> *Put the detergent in the correct compartment.*
- Softener is being taken early. >>> *There may be problem in the valves or in the detergent dispenser. Call the Authorised Service Agent.*

Foam is overflowing from the detergent drawer.

- Too much detergent is used. >>> *Mix 1 tablespoonful softener and ½ l water and pour into the main wash compartment of the detergent drawer.*
- Put detergent into the machine suitable for the programmes and maximum loads indicated in the "Programme and consumption table". When you use additional chemicals (stain removers, bleaches and etc), reduce the amount of detergent.

Laundry remains wet at the end of the programme. (*)

- Excessive foam might have occurred and automatic foam absorption system might have been activated due to too much detergent usage. >>> *Use recommended amount of detergent.*
- * Machine does not switch to spinning step when the laundry is not evenly distributed in the drum to prevent any damage to the machine and to its surrounding environment. Laundry should be rearranged and re-spun.
- ** Regular drum cleaning might not be applied.>>> *Clean the drum regularly.*



WARNING: If you cannot eliminate the problem although you follow the instructions in this section, consult the dealer or the Authorised Service Agent. Never try to repair a nonfunctional product yourself.

GRUNDIG NORDIC
GLYNITVEIEN 25, PB 234
1402 SKI, NORWAY