



WASHING MACHINE

USER'S MANUAL

GWN 59673 C

EN

www.grundig.com

GRUNDIG

Document Number 2820525592_EN/ 15-06-16.(15.04)



Please read this user manual first!

Dear Customer,

Thank you for preferring a Grundig product. We hope that you get the best results from your product which has been manufactured with high quality and state-of-the-art technology. Therefore, please read this entire user manual and all other accompanying documents carefully before using the product and keep it as a reference for future use. If you hand over the product to someone else, give this user manual as well. Follow all warnings and information in the user manual. Remember that this user manual is also applicable for several other models. Differences between models will be identified in the manual.

Explanation of symbols

Throughout this user manual the following symbols are used:

	Important information or useful hints about usage.
	Warning for hazardous situations with regard to life and property.
	Warning for electric shock.
	Recyclable materials.

Do not dispose of the packaging materials together with domestic or other wastes. Take them to the packaging material collection points designated by the local authorities.

TABLE OF CONTENTS

1 General safety instructions	5
1.1 Life and property safety	5
1.2 Children's safety	6
1.3 Electrical safety	6
1.4 Hot surface safety	7
2 Important instructions for the environment	8
2.1 Compliance with WEEE Directive	8
2.2 Package information	8
3 Intended use	8
4 Your product	9
4.1 Overview	9
4.2 Package Contents	10
4.3 Technical specifications	11
4.4 Installation	12
4.4.1 Appropriate installation location	12
4.4.2 Removing packaging reinforcement	12
4.4.3 Removing transportation safety bolts	13
4.4.4 Connecting water supply	13
4.4.5 Connecting the drain hose to the drain	14
4.4.6 Adjusting the feet	15
4.4.7 Electrical connection	15
4.4.8 Initial use	15
4.5 Preparation	16
4.5.1 Sorting the laundry	16
4.5.2 Preparing laundry for washing	17
4.5.3 Tips for energy saving	17
4.5.4 Loading the laundry	18
4.5.5 Correct load capacity	18
4.5.6 Using detergent and softener	18
4.5.7 Tips for efficient washing	20
4.6 Operating the product	21
4.6.1 Control panel	21
4.6.2 Display symbols	21
4.6.3 Programme and consumption table	22
4.6.4 Programme selection	24
4.6.5 Programmes	24

TABLE OF CONTENTS

4.6.6 Temperature selection	27
4.6.7 Spin speed selection	27
4.6.8 Soiling level selection	29
4.6.9 Stain Care (Stain level selection)	29
4.6.10 Dosing liquid detergent	30
4.6.11 Auxiliary function selection	31
4.6.12 Recommendations for the amount of laundry and detergent	32
4.6.13 End Time	33
4.6.14 Starting the programme	34
4.6.15 Loading door lock	34
4.6.16 Changing the selections after programme has started	34
4.6.17 Child Lock	35
4.6.18 Cancelling the programme	36
4.6.19 End of programme	36
4.6.20 Favourite program setting	37
4.6.21 Entering the settings menu	37
4.6.22 Your machine is equipped with a "Standby Mode"	41
4.7 Maintenance and cleaning	42
4.7.1 Cleaning the detergent drawer	42
4.7.2 Cleaning the loading door and the drum	43
4.7.3 Cleaning the body and control panel	43
4.7.4 Cleaning the water intake filters	44
4.7.5 Draining remaining water and cleaning the pump filter	44

5 Troubleshooting

46

1 General safety instructions

This section includes security instructions which may help prevent the injuries and material damage risks. All kinds of warranties shall be invalid if these instructions are not observed.

1.1 Life and property safety

- ▶ Never place the product on a carpet-covered floor. Electrical parts will get overheated since air cannot circulate from under the device. This will cause problems with your product.
- ▶ Unplug the product if it is not in use.
- ▶ Always have the repairing procedures carried out by an Authorised Service Agent. The manufacturer shall not be held liable for damages that may arise from procedures carried out by unauthorised persons.
- ▶ The water supply and draining hoses must be securely fastened and remain undamaged. Otherwise a water leak may occur.
- ▶ While there is water inside the product, never open the loading door or remove the filter. Otherwise, risk of flooding and injury from hot water will occur.
- ▶ Do not force open the locked loading door. The door can be opened a few minutes after the washing cycle ends. In the case of forcing the loading door to open, the door and the lock mechanism may get damaged.
- ▶ Use detergents, softeners and supplements suitable for automatic washing machines only.
- ▶ Follow the instructions on the label of textiles and the detergent package.

1.2 Children's safety

- ▶ This product can be used by children who are at the age of 8 and over and the people whose physical, sensory or mental skills are not fully developed or who do not have necessary required experience and knowledge as long as they are supervised or trained about the safe use of the product and its risks. Children should not play with the device. Cleaning and maintenance works should not be performed by children unless they are supervised by someone. Children of less than 3 years should be kept away unless continuously supervised.
- ▶ Packaging materials may be dangerous for children. Keep packaging materials in a safe place away from reach of children.
- ▶ Electrical products are dangerous for children. Keep children away from the product when it is in use. Do not allow them to play with the product. Use the child lock to prevent children from interfering with the product.
- ▶ Do not forget to close the loading door when leaving the room where the product is located.
- ▶ Store all detergents and additives in a safe place away from the reach of children and close the cover of the detergent container or seal the detergent package.

1.3 Electrical safety

- ▶ If the product has a failure, it should not be operated unless it is repaired by an Authorised Service Agent. Risk of electric shock!
- ▶ This product is designed to resume operating in the event of powering on after a power interruption. If you wish to cancel the programme, see "Cancelling the programme" section.

- ▶ Plug the product into a grounded outlet protected by a 13 A fuse. Do not neglect to have the grounding installation made by a qualified electrician. Our company shall not be liable for any damages that will arise when the product is used without grounding in accordance with the local regulations.
- ▶ Do not wash the product by spraying or pouring water onto it! Risk of electric shock!
- ▶ Never touch the power cable plug with wet hands! Do not grab the power cord to unplug the machine, always unplug it by holding the socket with one hand, and pulling the plug with the other hand.
- ▶ Product should be unplugged during installation, maintenance, cleaning and repair procedures.
- ▶ If the power cable is damaged, it must be replaced by the manufacturer, after sales service or a similarly qualified person (preferably an electrician) or someone designated by the importer in order to avoid possible risks.

1.4 Hot surface safety

	<p>While washing the laundry at high temperatures, the loading door glass will get hot. Considering this fact, during the washing operation keep children away from the loading door of the product to prevent them touching it.</p>
--	--

2 Important instructions for the environment

2.1 Compliance with WEEE Directive



This product complies with EU WEEE Directive (2012/19/EU). This product bears a classification symbol for waste electrical and electronic equipment (WEEE).

This product has been manufactured with high quality parts and materials which can be reused and are suitable for recycling. Do not dispose of the waste product with normal domestic and other wastes at the end of its service life. Take it to the collection center for the recycling of electrical and electronic equipment. Please consult your local authorities to learn about these collection centres.

Compliance with RoHS Directive:

The product you have purchased complies with EU RoHS Directive (2011/65/EU). It does not contain harmful and prohibited materials specified in the Directive.

2.2 Package information

Packaging materials of the product are manufactured from recyclable materials in accordance with our National Environment Regulations. Do not dispose of the packaging materials together with the domestic or other wastes. Take them to the packaging material collection points designated by the local authorities.

3 Intended use

- This product has been designed for domestic use. It is not for commercial purposes or it should not be used other than its intended use.
- The product must only be used for washing and rinsing of laundry that are marked accordingly.
- The manufacturer waives any responsibility arising from incorrect usage or transportation.
- The service life of your product is 10 years. During this period, original spare parts will be available to operate the appliance properly.

4 Your product

4.1 Overview

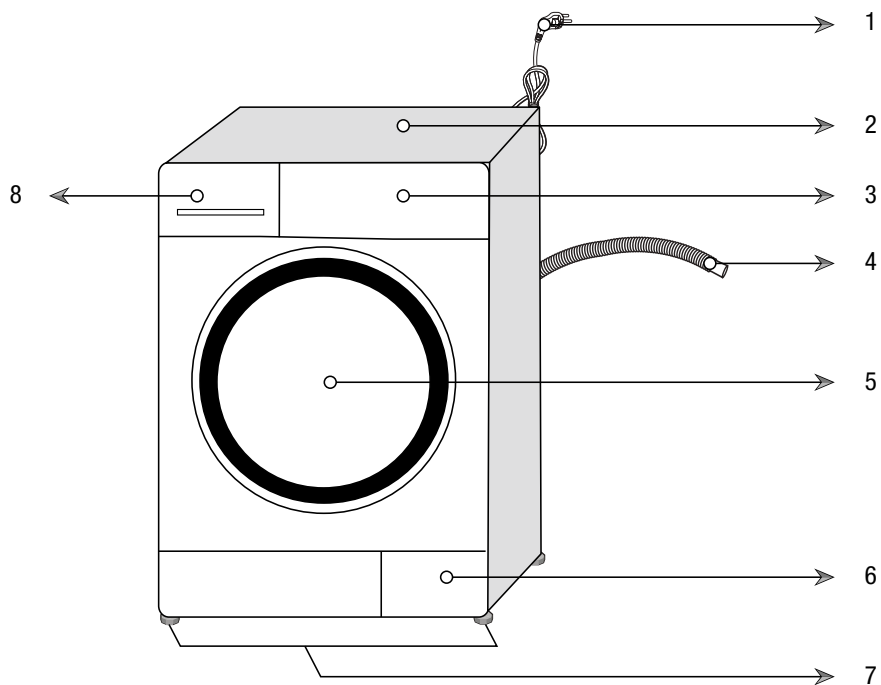

- 1- Power cable
- 2- Top panel
- 3- Control panel
- 4- Drain hose
- 5- Loading door
- 6- Filter cap
- 7- Adjustable feet
- 8- Detergent drawer

4.2 Package Contents

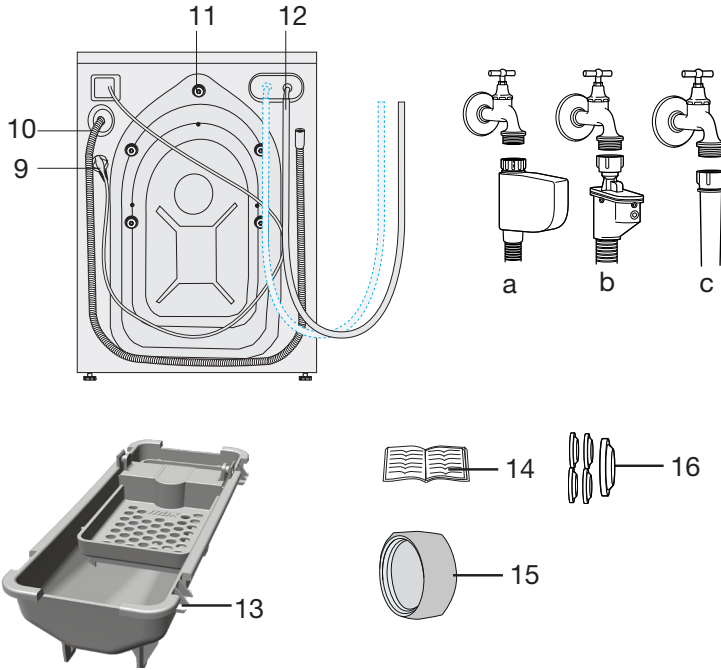

- 9- Power cable
 - 10- Drain hose
 - 11- Transportation safety bolts*
 - 12- Mains water inlet hose (One of the following filter types is used for the mains hose connection.)
 - a- Electronic water shut-off
 - b- Mechanical water shut-off
 - c- Standard
 - 13- Liquid detergent container**
 - 14- User Manual
 - 15- Blind plug***
 - 16- Plastic plug group
- * Number of transportation safety bolts may change depending on the model of your product.
** This may be supplied with the machine depending on the model of your product.
*** It will be supplied if your product has double water inlet.



Figures in this manual are schematic and may not match the product exactly.

4.3 Technical specifications

Complying Commission Delegated Regulation (EU) No 1061/2010	
Supplier name or trademark	GRUNDIG
Model name	GWN 59673 C
Rated capacity (kg)	9
Energy efficiency class / Scale from A+++ (Highest Efficiency) to D (Lowest Efficiency)	A+++
Annual Energy Consumption (kWh) ⁽¹⁾	173
Energy consumption of the standard 60°C cotton programme at full load (kWh)	0.880
Energy consumption of the standard 60°C cotton programme at partial load (kWh)	0.690
Energy consumption of the standard 40°C cotton programme at partial load (kWh)	0.660
Power consumption in 'off-mode' (W)	0.500
Power consumption in 'left-on mode' (W)	0.800
Annual Water Consumption (l) ⁽²⁾	10560
Spin-drying efficiency class / Scale from A (Highest Efficiency) to G (Lowest Efficiency)	A
Maximum spin speed (rpm)	1600
Remaining moisture Content (%)	44
Standard cotton programme ⁽³⁾	Cotton Eco 60°C and 40°C
Programme time of the standard 60°C cotton programme at full load (min)	225
Programme time of the standard 60°C cotton programme at partial load (min)	182
Programme time of the standard 40°C cotton programme at partial load (min)	171
Duration of the left-on mode (min)	N/A
Airborne acoustical noise emissions washing/spinning (dB)	50/75
Built-in	No
Height (cm)	84
Width (cm)	60
Depth (cm)	61
Net weight (±4 kg.)	78
Single Water inlet / Double Water inlet	• / -
• Available	
Electrical input (V/Hz)	230 V / 50Hz
Total current (A)	10
Total power (W)	2200
Main model code	958
⁽¹⁾ Energy Consumption based on 220 standard washing cycles for cotton programmes at 60°C and 40°C at full and partial load, and the consumption of the low-power modes. Actual energy consumption will depend on how the appliance is used.	
⁽²⁾ Water consumption based on 220 standard washing cycles for cotton programmes at 60°C and 40°C at full and partial load. Actual water consumption will depend on how the appliance is used.	
⁽³⁾ "Standard 60°C cotton programme" and the "standard 40°C cotton programme" are the standard washing programmes to which the information in the label and the fiche relates and these programmes are suitable to clean normally soiled cotton laundry and that they are the most efficient programmes in terms of combined energy and water consumption.	
Technical specifications may be changed without prior notice to improve the quality of the product.	

4.4 Installation

- Apply to the nearest authorized service agent for the installation of your product.
- Preparation of the location and electrical, tap water and waste water installations at the place of installation is under customer's responsibility.
- Make sure that the water inlet and discharge hoses as well as the power cable are not folded, pinched or crushed while pushing the product into its place after installation or cleaning procedures.
- Make sure that the installation and electrical connections of the product are performed by authorized service. Manufacturer shall not be held liable for damages that may arise from procedures carried out by unauthorized persons.
- Prior to installation, visually check if the product has any defects on it. If so, do not have it installed. Damaged products cause risks for your safety.

4.4.1 Appropriate installation location

- Place the product on a hard and level floor. Do not put it onto a carpet with high pile or other similar surfaces.
- When the washing machine and drier are placed on top of each other, their total weight –when loaded– amounts to 180 kilograms. Place the product on a solid and flat floor that has sufficient load carrying capacity!
- Do not place the product on the power cable.
- Do not install the product in the environments where the temperature falls below 0 °C.
- Leave a minimum space of 1 cm between the machine and the furniture.
- If you will install the product on a surface with steps, never put it on place near the edge.
- Do not place the product on any platform.

4.4.2 Removing packaging reinforcement



Tilt the product backwards to remove the packaging reinforcement. Remove the packaging reinforcement by pulling the ribbon. Do not make this operation alone by yourself.

4.4.3 Removing transportation safety bolts

- 1 Loosen all transportation safety bolts with an appropriate wrench until they turn freely. **(C)**.
- 2 Remove the transport safety bolts by turning them slightly.
- 3 Insert the plastic covers in the bag containing the user manual to the openings on the rear panel. **(P)**

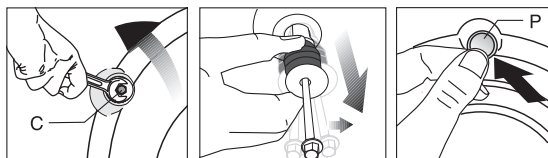

CAUTION: Remove the transportation safety bolts before operating the product! Otherwise, the product will be damaged.



Keep the transportation safety bolts in a safe place to reuse when the product needs to be moved again in the future.

Install the transport safety bolts in reverse order of the disassembly procedure.

Never move the product without the transportation safety bolts properly fixed in place!

4.4.4 Connecting water supply



The water supply pressure required to run the product is between 1 to 10 bars (0.1 - 10 MPa). It is necessary to have 10 - 80 liters of water flowing from the fully open tap in 1 minute to have your product run smoothly. Attach a pressure reducing valve if water pressure is higher.



CAUTION: Models with a single water inlet should not be connected to the hot water tap. In such a case the laundry will get damaged or the product will switch to protection mode and will not operate.

CAUTION: Do not use old or used water inlet hoses on the new product. It may cause stains on your laundry.

- 1 Tighten the nuts of the hose by hand. Never use a tool when tightening the nuts.
- 2 When hose connection is completed, check whether there is leak problems at the connection points by opening the taps fully. If any leaks occur, turn off the tap and remove the nut. Retighten the nut carefully after checking the seal. In order to prevent the water leaks and resultant damages, keep the taps closed when you do not use the product.

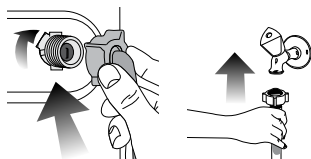

4.4.5 Connecting the drain hose to the drain

- Attach the end of the drain hose directly to waste water drain, lavatory or bathtub.



CAUTION: Your drain house will be flooded if the hose comes out of its housing during water discharge. Moreover, there is risk of scalding due to high washing temperatures! In order to prevent such situations and make sure that the product and the machine performs water intake and discharge processes without any problem, fix the drain hose securely.

- Connect the drain hose to a minimum height of 40 cm and a maximum height of 100 cm.
- In case the drain hose is elevated after laying it on the floor level or close to the ground (less than 40 cm above the ground), water discharge becomes more difficult and the laundry may come out excessively wet. Therefore, follow the heights described in the figure.

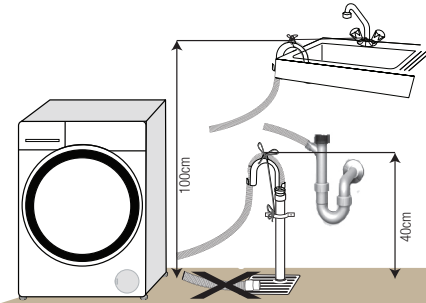

- To prevent the waste water to go back into the product again and to ensure easy drainage, do not immerse the end of the hose into the waste water or do not insert it into the drain for more than 15 cm. If it is too long, cut it short.
- The end of the hose should not be bent, it should not be stepped on and the hose must not be pinched between the drain and the machine.
- If the length of the hose is too short, use it by adding an original extension hose. Length of the hose may not be longer than 3.2 m. To avoid water leak failures, the connection between the extension hose and the drain hose of the product must be fitted well with an appropriate clamp as not to come off and leak.

4.4.6 Adjusting the feet



CAUTION: In order to ensure that the product operates more silently and vibration-free, it must stand level and balanced on its feet. Balance the machine by adjusting the feet. Otherwise, the product may move from its place and cause crushing and vibration problems.

CAUTION: Do not use any tools to loosen the lock nuts. Otherwise, they will get damaged.

- 1 Loosen the lock nuts on the feet by hand.
- 2 Adjust the feet until the product stands in a stable and balanced way.
3. Tighten all lock nuts by hand again.

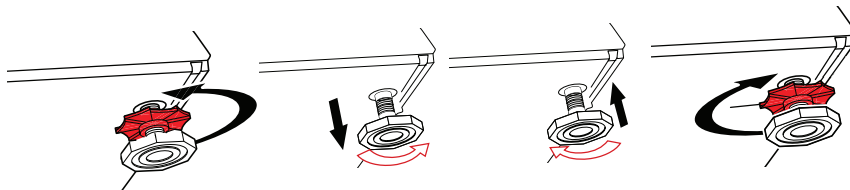

4.4.7 Electrical connection

Connect the product to a grounded outlet protected by a 16 A fuse. Our company shall not be liable for any damages that will arise when the product is used without grounding in accordance with the local regulations.

- Connection must comply with national regulations.
- Power cable plug must be within easy reach after installation.
- If the current value of the fuse or breaker in the house is less than 16 Amps, have a qualified electrician install a 16 Amp fuse.
- The voltage specified in the "4.3 Technical specifications" section must be equal to your mains voltage.
- Do not make connections via extension cables or multi-plugs.



CAUTION: Damaged power cables must be replaced by the Authorized Service Agents.

4.4.8 Initial use

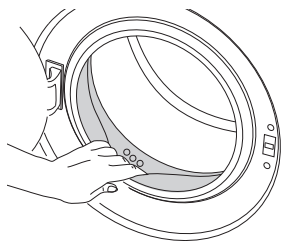

Before starting to use the product make sure that the preparations are made which are in line with the "2. Important Safety and Environment Instructions" and the instructions in the "4.4 Installation" section.

To prepare the product for washing laundry, perform first operation in Drum Cleaning programme. If this program is not available in your product, apply the method which is described in the section "4.7.2 Cleaning the loading door and the drum".



























Use an anti-limescale suitable for the washing machines.

Some water might have remained in the product due to the quality control processes in the production. It is not harmful for the product.

4.5 Preparation

4.5.1 Sorting the laundry

- Sort laundry according to type of fabric, color, and degree of soiling and allowable water temperature.
- Always observe the instructions given on the garment care labels.

LAUNDRY WASH SYMBOLS													
	Machine Wash Symbols												
	WASH	Water Temperatures	Maximum Symbol(s)	95°C •••	70°C •••	60°C ••	50°C •••	40°C ••	30°C •				
	Drying Symbols												
	DRYING	Drying Settings	At any temperature ○	At high temperature ○••	At medium temperature ○•	At low temperature ○•	Without heating ●	Hang to dry ◐	Lay to dry ◑	Hang wet to dry ▨	Lay in shadow to dry ▧	Dry-cleanable Ⓟ	
	Iron -												
	IRON	Dry or Steam	Iron at high temperature	Iron at medium temperature	Iron at low temperature	Do not iron	Iron without steam						
	Maximum temperature		200 °C	150 °C	110 °C								
	BLEACH		All bleaches are allowed			Bleach (sodium hypochlorite) can be used			Bleach is not allowed			Only bleaches without chlorine are allowed	

4.5.2 Preparing laundry for washing

- Laundry items with metal attachments such as, underwiring, belt buckles or metal buttons will damage the product. Remove the metal pieces or wash such clothes by putting them in a laundry bag or pillow case.
- Take out all substances in the pockets such as coins, pens and paper clips, and turn pockets inside out and brush. Such objects may damage the product or cause noise problem.
- Put small size clothes such as infant's socks and nylon stockings in a laundry bag or pillow case.
- Place curtains in without compressing them. Remove curtain attachment items.
- Fasten zippers, sew loose buttons and mend rips and tears.
- Wash "Machine washable" or "Hand washable" labeled products only with an appropriate programme.
- Do not wash colours and whites together. New, dark coloured cottons release a lot of dye. Wash them separately.
- Tough stains must be treated properly before washing. If unsure, check with a dry cleaner.
- Only use the dyes / color changers and descaling agents which are appropriate for machine wash. Always follow the instructions on the package.
- Wash trousers and delicate laundry turned inside out.
- Keep laundry items made of Angora wool in the freezer for a few hours before washing. This will reduce pilling.
- Laundry that are subjected to materials such as flour, lime dust, milk powder, etc. intensely must be shaken off before placing into the product. Such dusts and powders on the laundry may build up on the inner parts of the product in time and can cause damage.

4.5.3 Tips for energy saving

Following information will help you use the product in an ecological and energy-efficient manner.

- Operate the product in the highest load capacity allowed for the programme you have selected, but do not overload. See, "4.6.3 Programme and consumption table."
- Observe the temperature instructions on the detergent packaging.
- Wash slightly soiled laundry at low temperatures.
- Use faster programmes for small quantities of lightly soiled laundry.
- Do not use prewash and high temperatures for laundry that is not heavily soiled or stained.
- If you plan to dry your laundry in a dryer, select the highest spin speed recommended during washing process.
- Do not use more detergent than the recommended on the detergent packaging.

4.5.4 Loading the laundry

1. Open the loading door.
2. Put the laundry items into the product in a loose manner.
- 3 Push the loading door to close until you hear a locking sound. Ensure that no items are caught in the door. The loading door is locked while a programme is running. The loading door is unlocked a while after the programme comes to an end. Then you can open the loading door.

4.5.5 Correct load capacity

The maximum load capacity depends on the type of laundry, the degree of soiling and the washing programme desired.

The product automatically adjusts the water amount according to the weight of the laundry put inside it.



WARNING: Comply with the information in the section "4.6.3 Programme and consumption table". When overloaded, product's washing performance will drop. Moreover, noise and vibration problems may occur.

4.5.6 Using detergent and softener



When using detergent, softener, starch, fabric dye, bleach and descaling agents; read the manufacturer's instructions written on the package and follow the dosages specified. Use measuring cup if available.

Detergent, softener and other cleaning agents

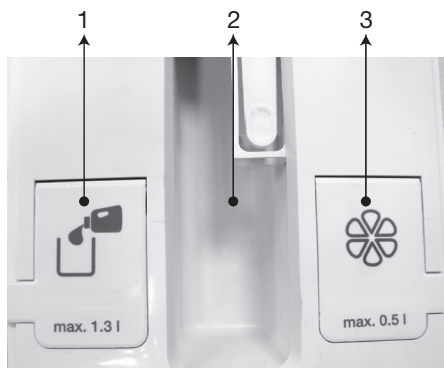

- 1- Liquid detergent compartment
- 2 - Powder detergent compartment
- 3 - Softener compartment

- Add detergent and softener before starting the washing programme.
- While the washing cycle is in progress, do not leave the detergent drawer open!
- There is no pre-wash compartment and pre-wash option.
- Place the detergent bag or the dispensing ball directly among the laundry in the product.

Choosing the detergent type



For programmes for which operation of dosing system is allowed 'detergent symbol' will flash on display. 'Liquid Detergent Selected' text will be displayed.

- For some programmes of the machine, liquid detergent could not be selected. In such cases, powder detergent should be used.
- After selecting the temperature, spin speed, auxiliary function and soiling level the programme is started with start/pause button.
- The machine will measure the load, and determine the detergent amount depending on the load amount and selected functions. During the washing operation, the detergent intake is not visible, it will be intaken directly with the water.

Powder Detergent Usage in Detergent Dosing System Programmes:



If it is requested to use powder detergent in programmes where detergent dosing system activates required amount of powder detergent should be added to the detergent compartment. After selecting the programme, temperature, spin speed, auxiliary function and soiling level of the laundry, press the 'powder detergent' button.

'Powder Detergent Selected' text will be displayed. Program is started by pressing Start/Pause button.

When the machine starts to take in water, detergent will also be taken in.

- Softener will be taken in through the detergent dosing system.

Run Out of Detergent and/or Softener:

- When the detergent in the detergent drawer runs out 'detergent symbol' will flash on the display, 'Detergent Dosing Error' text will be displayed.



You must add detergent into the tank when the detergent is depleted. Your machine does not allow starting the programme when the detergent tank is empty.

Adding Detergent and Softener to Wrong Compartment:

- If the detergent and softener are added to wrong compartments see 4.7.1 Cleaning the detergent drawer

4.5.7 Tips for efficient washing

		Clothes			
		Light Colours and Whites	Colours	Black/Dark Colours	Delicates/Woolens/Silks
		(Recommended temperature range based on soiling level: 40-90 °C)	(Recommended temperature range based on soiling level: cold -40 °C)	(Recommended temperature range based on soiling level: cold -40 °C)	(Recommended temperature range based on soiling level: cold-30 °C)
Soiling Level	Heavily Soiled (difficult stains such as grass, coffee, fruits and blood.)	It may be necessary to pre-treat the stains or perform prewash. Powder and liquid detergents recommended for whites can be used at dosages recommended for heavily soiled clothes. It is recommended to use powder detergents to clean clay and soil stains and the stains that are sensitive to bleaches.	Powder and liquid detergents recommended for colors can be used at dosages recommended for heavily soiled clothes. It is recommended to use powder detergents to clean clay and soil stains and the stains that are sensitive to bleaches. Detergents which do not contain bleach should be used.	Liquid detergents suitable for colors and dark colors can be used at dosages recommended for heavily soiled clothes.	Prefer liquid detergents produced for delicate clothes. Woolen and silk clothes must be washed with special woolen detergents.
	Normally Soiled (For example, stains caused by body on collars and cuffs)	Powder and liquid detergents recommended for whites can be used at dosages recommended for normally soiled clothes.	Powder and liquid detergents recommended for colors can be used at dosages recommended for normally soiled clothes. Detergents which do not contain bleach should be used.	Liquid detergents suitable for colors and dark colors can be used at dosages recommended for normally soiled clothes.	Prefer liquid detergents produced for delicate clothes. Woolen and silk clothes must be washed with special woolen detergents.
	Lightly Soiled (No visible stains exist.)	Powder and liquid detergents recommended for whites can be used at dosages recommended for lightly soiled clothes.	Powder and liquid detergents recommended for colors can be used at dosages recommended for lightly soiled clothes. Detergents which do not contain bleach should be used.	Liquid detergents suitable for colors and dark colors can be used at dosages recommended for lightly soiled clothes.	Prefer liquid detergents produced for delicate clothes. Woolen and silk clothes must be washed with special woolen detergents.



If special liquid detergent will be used; select powder detergent and fill the compartment no. 2 with the special detergent. In such cases, no time delay function should not be used.

4.6 Operating the product

4.6.1 Control panel

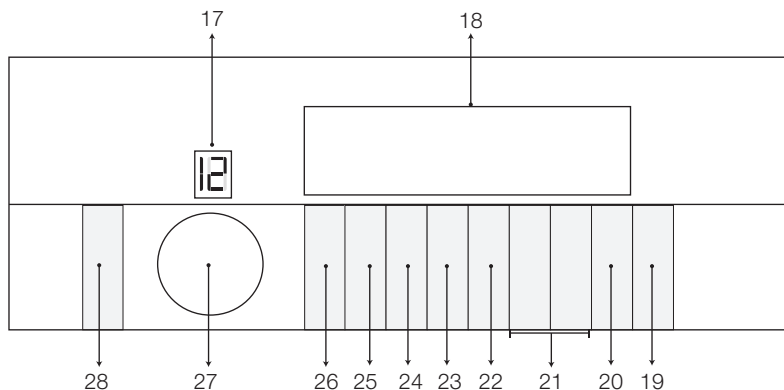

- 17 - Programme Selection display
- 18 - Display
- 19 - Start / Pause button
- 20 - End Time Setting button
- 21 - Auxiliary Function buttons
- 22 - Favourite Programme button

- 23 - Dosing liquid detergent
- 24 - Soiling Level Adjustment button
- 25 - Spin speed adjustment button
- 26 - Temperature Adjustment button
- 27 - Programme Selection knob
- 28 - On / Off button

4.6.2 Display symbols

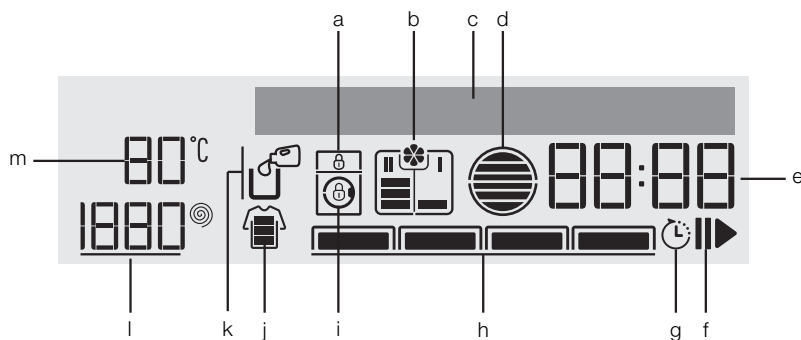

- a - Child-Proof Lock Indicator
- b - Powder detergent symbol
- c - Display Information Line
- d - Load indicator (displays the recommended amount of load)
- e - Time indicator

- f - Start / Pause indicator
- g - En Time indicator
- h - Auxiliary Function indicator
- i - Door Lock indicator
- j - Soiling Level indicator
- k - Liquid Detergent Symbol
- l - Spin speed indicator
- m - Temperature indicator



Figures in this section are schematic and may not match the product exactly.

4.6.3 Programme and consumption table

EN									
Programme (°C)		Max. Load (kg)	Water Consumption (l)	Energy Consumption (kWh)	Max. Speed***	Extra Rinse	Silent Mode	Detergent Dosing & powder detergent	Selectable temperature range °C
Cotton	90	9	70	2.03	1600	•	•	•	Cold-90
	60	9	70	1.33	1600	•	•	•	Cold-90
	40	9	70	0.93	1600	•	•	•	Cold-90
Cotton Eco	60**	9	52	0.88	1600			*	Cold-60
	60**	4.5	45	0.69	1600			*	Cold-60
	40**	4.5	45	0.66	1600			*	Cold-60
Anti Allergy	90	9	100	2.25	1600	*		•	30-90
Synthetics	60	4	65	1.13	1200	•	•	•	Cold-60
	40	4	65	0.90	1200	•	•	•	Cold-60
Steam Refresh	-	1	1	0.17	-				-
WoolProtect	40	2	45	0.35	1000	•	•	•	Cold-40
Bedding	40	-	67	0.82	1000	•	•	•	Cold-60
MultiSense	40	9	****	****	1600	•	•	•	Cold-60
StainCare	60	6	****	****	1600			•	40-90
Mini 14'	30	2	34	0.16	1400	•	•	•	Cold-30
Hand Wash	30	1.5	40	0.22	1000	•		•	Cold-30
QuickWash 40°/40'	40	8	55	0.65	1400			•	40
DarkCare	40	4	80	0.90	1000	*	•	•	Cold-40
MachineCare	70	-	110	2.60	600	*		*	70

• : Selectable.

* : Automatically selected, no canceling.

** : Energy Label programme (EN 60456 Ed.3)

*** : If maximum spin speed of the product is lower then this value, you can only select up to the maximum spin speed.

**** : Programme detects the type and quantity of the laundry to automatically adjust water and energy consumption and programme time.

- : See the programme description for maximum load.

 ** "Cotton Economic 40°C" and "Cotton Economic 60°C" are standard programmes. These programmes are known as "40°C cotton standard programme" and "60°C cotton standard programme" and indicated with the  <40> <60> symbols on the panel.



The auxiliary functions in the table may vary according to the model of your product.

Water and power consumption may vary subject to the changes in water pressure, water hardness and temperature, ambient temperature, type and amount of laundry, selection of auxiliary functions and spin speed, and changes in electric voltage.

You can see the washing time of the programme you have selected on the display of the product. It is normal that small differences may occur between the time shown on the display and the real washing time.

Auxiliary function selection modes can be changed by the manufacturing company. Existing selection modes can be removed or new selection modes can be added.

The manufacturer reserves the right to make modifications in the programmes and auxiliary functions given in the table. While these modifications will not change the product performance, programme steps and durations can be changed."

Indicative values for Synthetics programmes (EN)

	Load (kg)	Water Consumption (l)	Energy Consumption (kWh)	Programme Duration (min) *	Remaining Moisture Content (%) ** ≤ 1000 rpm	Remaining Moisture Content (%) ** > 1000 rpm
Synthetics 60	4	65	1.13	90/110	45	40
Synthetics 40	4	65	0.90	80/100	45	40

* You can see the washing time of the programme you have selected on the display of the machine. It is normal that small differences may occur between the time shown on the display and the real washing time.

** Remaining moisture content values may differ according to the selected spin speed.

Cotton (Cottons)	Synthetics	GentleCare	Darkcare	BabyProtect+	Woolens	Freshen Up	Night mode	Hand wash	Self Clean	Mini 14	Mini	Quick Wash	Shirts
Spin	Prewash	Anti creasing	Rinse Plus	Rinse	Temperature	Time Delay	Child Lock	On/Off	Start Pause	Cold	No Spin	Delicate	Drying
Autoprogramme	Wash	End	Spin+Drain	Cotton Eco	40°/40'	Rinse Hold	Soiling Level Adjustment	Favourite	Detergent Dosing & powder detergent				
Duvet Bedding													

4.6.4 Programme selection

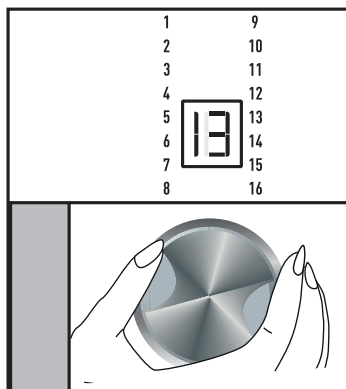

- 1 Determine the programme suitable for the type, quantity and soiling level of the laundry in accordance with "4.6.3 Programme and consumption table".



Programmes are limited with the highest spin speed appropriate for that particular type of fabric.

When selecting a programme, always consider the type of fabric, colour, degree of soiling and permissible water temperature.

Always select the lowest appropriate temperature. Higher temperature means higher power consumption.

- 2 Select the desired programme with the **Programme Selection** knob.

4.6.5 Programmes

• Cotton Eco

Use to wash your normally soiled, durable cotton and linen laundry. Although it washes longer than all other programmes, it provides high energy and water savings. Actual water temperature may be different from the stated wash temperature. When you load the machine with less laundry (e.g. 1/2 capacity or less), programme time may automatically get shorter. In this case, energy and water consumption will decrease more, providing a more economic wash. This programme is available in the models with the remaining time indicator.

• Cotton

Use for your cotton laundry (such as bed sheets, duvet and pillowcase sets, towels, bathrobes, underwear, etc.). Your laundry will be washed with vigorous washing action for a longer washing cycle.

• Synthetics

Use to wash your synthetic clothes (shirts, blouses, synthetic/cotton blends, etc.). It washes with a gentle action and has a shorter washing cycle compared to the Cottons programme.

For curtains and tulle, use the Synthetic 40°C programme with anti-creasing function selected. As their meshed texture causes excessive foaming, wash the veils/tulle with a little amount of detergent.

• WoolProtect

Use to wash your woolen clothes. Select the appropriate temperature complying with the care labels of your clothes. Use appropriate detergents for woolens. Instead of detergent dosing system, the detergent drawer should be manually filled with appropriate amount of powder or liquid detergent.



APPAREL CARE

"The wool wash cycle of this machine has been approved by The Woolmark Company for the washing of machine washable wool products provided that the products are washed according to the instructions on the garment label and those issued by the manufacturer of this washing machine.M13985

"In UK, Eire, Hong Kong and India the Woolmark trade mark is a Certification trade mark."

• Hand Wash

Use to wash your woolen/delicate clothes that bear "not machine-washable" tags and for which hand wash is recommended. It washes laundry with a very gentle washing action to not to damage clothes.

• Anti-Allergy

Use to wash baby laundry, and the laundry that belongs to allergic persons. Longer heating time and an additional rinsing step provide a higher level of hygiene.

• Bedding

Use this programme to wash your fiber duvets that bear "machine washable" tag. Make sure that you have loaded the duvet correctly in order not to damage the machine and the duvet. Remove the duvet cover before loading the duvet into the machine. Fold the duvet into two and load it into the machine. Load the duvet into the machine paying attention to place it in a way that it will not contact the bellow.



Do not load more than 1 double fiber duvet (200 x 200 cm).

Do not wash your duvets, pillows and etc. that contain cotton in the machine.



CAUTION: Do not wash the items apart from duvets such as carpets, rugs and etc. in the machine. Permanent damage occurs in the machine.

• Spin + Pump

Use to drain the water in the machine.

• Rinsing

Use when you want to rinse or starch separately.

• Steam Refresh

Use this programme to reduce the creases and ironing times of a small amount of unspotted cotton, synthetic or mixed laundry.



Load only half of the capacity stated for the selected programme.

When this programme is selected, it is normal to hear boiling noises since the steam generator boils water to produce steam.

• Mini 14'

Use to wash lightly soiled and unstained cotton laundry in a short time.

- **MultiSense**

Use to wash frequently washable cotton, synthetic or blended (cotton+synthetic) clothes. Programme detects the type and quantity of the laundry to automatically adjust water consumption and programme time.



CAUTION: Do not wash your woolen and delicate clothes in this programme. Select a suitable temperature if the temperature shown on the temperature display is not compatible with the warnings on the garment label.

The maximum washing temperature in Automatic programme depending on the soiling level and laundry type is 60°C. Washing performance may not be at the desired level for heavily soiled whites and stubborn stains (collar, sock soil, perspiration stain, etc.). In this case, it is recommended to select Cottons programme and set the temperature to 50-60°C.

Many types of clothing are correctly detected and safely washed in Automatic programme.

- **Quick Wash 40° / 40'**

Use this programme to wash your lightly soiled and unstained cotton laundry in a short time.

- **DarkCare**

Use this programme to wash your dark coloured **cotton and synthetic** laundry or the laundry that you do not want it get faded. Washing is performed with gentle actions and at low temperatures. It is recommended to use liquid detergent or woolen shampoo for dark coloured laundry.

- **MachineCare**

Use regularly (once in every 1-2 months) to clean the drum and provide the required hygiene. Run the programme without any laundry in the machine. To obtain better results, put powder limescale remover for washing machines into the detergent compartment nr. "2". When the programme is over, leave the loading door ajar so that the inside of the machine gets dry.



This is not a washing programme. It is a maintenance programme.

Do not run the programme when there is something in the machine. If you try to do so, the machine detects that there is a load inside and aborts the programme.

4.6.6 Temperature selection

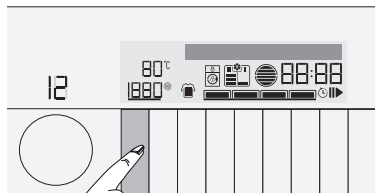

Whenever a new programme is selected, the recommended temperature for the programme appears on the temperature indicator. It is possible that the recommended temperature value is not the maximum temperature that can be selected for the current programme.

Press the **Temperature Adjustment** button to change the temperature. Temperature will decrease by steps of 10 °C.



Temperature Adjustment button only serves for decreasing the temperature.

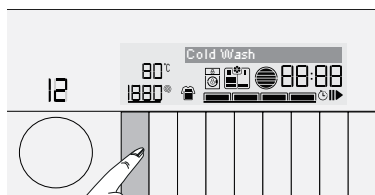

Finally, "-" symbol indicating the cold wash option appears on the display. "Cold Wash" appears on the display.



"-" symbol will be displayed for the programmes where temperature adjustment is not allowed. When you press the Temperature Adjustment button, "Unadjustable" appears on the display.

You can change the temperature after the washing is started until it is appropriate.



If you scroll to cold wash option and press Temperature Adjustment button again, the recommended maximum temperature for the selected programme appears on the display. Press the Temperature Adjustment button again to decrease the temperature.

4.6.7 Spin speed selection

Whenever a new programme is selected, the recommended spin speed of the selected programme is displayed on the **Spin Speed** indicator.



It is possible that the recommended spin speed value is not the maximum spin speed that can be selected for the current programme.

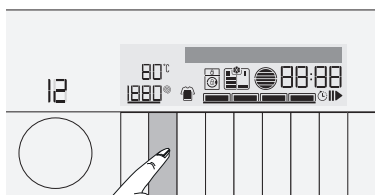

Press the **Spin Speed Adjustment** button to change the spin speed. Spin speed decreases in steps.

Then, depending on the model of the product, "Rinse Hold" and "No Spin" options appear on the display.



Spin Speed Adjustment button only serves for decreasing the spin speed.

Rinse Hold option is indicated with " _ _ " symbol and No Spin option is indicated with " _ _ " symbol.

If you are not going to unload your laundry immediately after the programme completes, you can use **Rinse Hold** function in order to prevent them from getting wrinkled when there is no water in the machine.

This function holds the laundry in the final rinsing water.

If you want to spin your laundry after the Rinse Hold function:

- Adjust the **Spin Speed**.

- Press the **Start / Pause** button. The programme resumes. Machine drains the water and spins the laundry.

If you want to drain the water at the end of the programme without spinning, use **No Spin** function.

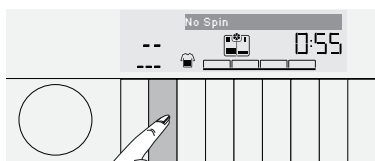
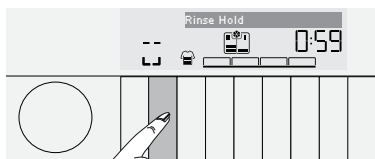

Rinse Hold

If you are not going to unload your clothes immediately after the programme completes, you can use rinse hold function to keep your laundry in the final rinsing water in order to prevent them from getting wrinkled when there is no water in the product. Press Start/Pause button after this process if you want to drain the water without spinning your laundry. Programme will resume and complete after draining the water.

If you want to spin the laundry held in water, adjust the Spin Speed and press Start / Pause button.

The programme resumes. Water is drained, laundry is spun and the programme is completed.



"- - -" symbol will be displayed for the programmes where spin speed adjustment is not allowed. When you press the Spin Speed Adjustment button, "Non-adjustable" appears on the display.

You can also change the Spin Speed after the washing starts.

4.6.8 Soiling level selection

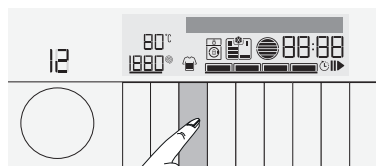
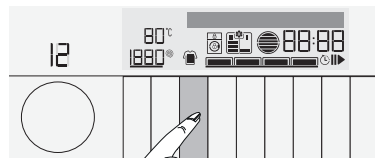

Whenever a new programme is selected, the soiling level recommended for that programme appears on the Soiling Level indicator. To change the soiling level, press the Soiling Level Adjustment button.



Soiling Level Adjustment button only serves for decreasing the soiling level.

Single line means "lightly soiled", double lines "moderately soiled", and three lines "heavily soiled".



If the user attempts to select a soiling level, which is not suitable for the selected programme, "Unadjustable" appears on the display.

4.6.9 Stain Care (Stain level selection)

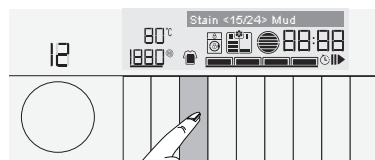
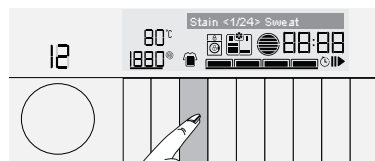

The machine has a special stain programme which enables the removal of different type of stains in the most effective way. Use this programme only for durable colorfast cotton laundry, do not wash delicate and pigmenting clothes and laundry in this programme. Before washing, garment tags should be checked (recommended for cotton shirts, trousers, shorts, t-shirts, baby clothes, pyjamas, aprons, table clothes, beddings, duvet cover, bed sheet, pillowcase, bath-beach towel, towel, socks, cotton underwears that are suitable for washing at high temperature and long time)



Before washing, apply pretreatment to the laundry depending on the type of the stain.

In the stain programme, you can select one of the following 24 different types of stains. Depending on the selected stain type a special washing program for which duration of rinse hold, washing action, washing and rinsing duration are modified.

The display order of the stain types are as follows (from left to right)

Sweat	Collar soil	Tea	Coffee	Meal	Fruit juice	Ketchup	Mayonnaise
Salad dressing	Make-up	Blood	Red wine	Chocolate	Pudding	Mud	Grass
Baby food	Egg	Machine oil	Starch	Butter	Jam	Curry	Coal

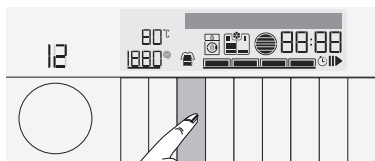

- Select the stain programme.
- Select the Stain type you want to clean pressing the Soiling Level Adjustment Button.
- Read the garment tag carefully and ensure that correct temperature and spin speed is selected.
- In the stain removal programme, no auxiliary function can be selected other than anticleansing and rinse hold.

General Tips for Stain Removal

- Do not wait too long to clean stained laundry, apply the pretreatment recommended according to the stain type while the stain is still fresh.
- Apply pretreatment to the stain using liquid or powder special stain remover, liquid detergent or a little amount of paste of water and powder detergent.
- It is recommended to use cold water for applying pretreatment to stains with unknown type.
- Before applying pretreatment to the stain, read the garment's tag to ensure that no condition that may harm the garment exists.
- The stain remover may cause discoloration on the fabric, to test it apply a little amount of stain remover to an unseen part of the fabric (such as reverse of it next to stitches).
- After applying the pretreatment rinse the garment well and wash it normally in the machine.

4.6.10 Dosing liquid detergent



Installation:

Switch on the machine pressing the ON/OFF button.

In programmes where using detergent dosing system is allowed 'detergent symbol' will flash. 'Ad Liquid Detergent' text will be displayed.

Adding liquid detergents and softeners



- Open the detergent drawer.



- Open the lid of the relevant compartment to fill the liquid detergent / softener.

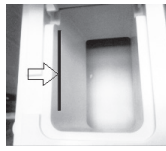

- Make sure not to pass the line.



- Close the lid.
 - Slowly close the detergent drawer.
 - After closing the detergent drawer, the flashing 'detergent symbol' will start to lit steadily.
 - Indicates that the components are filled and the drawer is closed.
- For coloured and white laundry, it is recommended to fill commonly used liquid detergent in the compartment.
 - Despite the fact that the detergent compartments are filled, if 'detergent symbol' continues to flash, the detergent drawer is not fully closed. Ensure that the drawer is seated in place by pushing it.



- While the detergent drawer is full with detergent and/or softener:
 - a- Do not pull the machine,
 - b- Do not change its place,
 - c- Do not tilt the machine to its side or back.
- To make these actions, first you should take out the drawer from the machine.
- If you want to run a programme with an empty drawer, you should press the 'powder detergent' button.

4.6.11 Auxiliary function selection

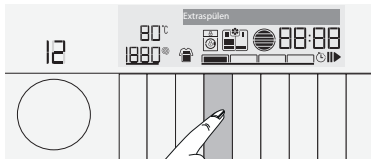

Select the desired auxiliary functions before starting the programme. Whenever a programme is selected, frames of the auxiliary function symbol that can be selected together with it illuminates. And when you select an auxiliary function, the interior area of the auxiliary function symbol also starts to illuminate and the name of the selected function appears on display for "3" seconds.



Frame of the auxiliary function symbol that cannot be selected with the current programme does not illuminate. When you press the button of such auxiliary functions, "Non-adjustable" appears on the display for 3 seconds.

Also the frames of the auxiliary function suitable for the current programme after the washing has started remains illuminated. You can select or cancel the auxiliary functions whose frames are illuminated. If the wash cycle has reached a point where you cannot select the auxiliary function, the function's frame turns off.



Some functions cannot be selected together. If a second auxiliary function conflicting with the first one is selected before starting the product, the function selected first will be canceled and the second auxiliary function selection will remain active. For example, if you want to select Quick Wash after you have selected the Additional Water, Additional Water will be canceled and Quick Wash will remain active.

An auxiliary function that is not compatible with the programme cannot be selected. (See, "4.6.3 Programme and consumption table")

Some programmes have auxiliary functions that must be operated simultaneously. Those functions cannot be cancelled. The frame of the auxiliary function will not be illuminated, only inner area will be illuminated.

• Extra Rinse

This function enables the product to make another rinsing in addition to the one already made after the main wash. Thus, the risk for sensitive skins (babies, allergic skins, etc.) to be effected by the minimal detergent remnants on the laundry can be reduced.



Pressing for the first time will add single rinse, a second press will add double rinse. The third press will cancel it.

• Silent Mode

Use to wash the cottons with lesser energy consumption and silently. Spin steps are cancelled for a silent washing and the cycle ends with the Rinse Hold step. After completion of the programme, run Spin cycle to spin the laundry.

4.6.12 Recommendations for the amount of laundry and detergent

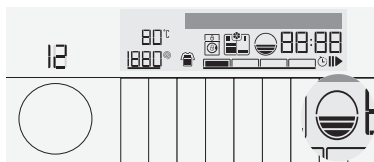

The amount of loaded laundry is measured when the loading door is open and the Load indicator shows the amount.

This information disappears when the loading door is closed.

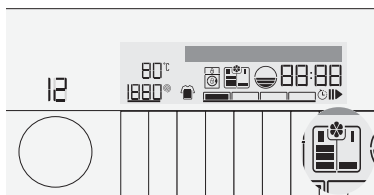

When powder detergent is selected; The detergent indicator shows the recommended amount of detergent according to the selected programme, soiling level and the amount of loaded laundry.

One line corresponds to a full powder detergent measurement cup supplied with your product.

If you use liquid detergent, follow the amounts recommended by the detergent manufacturer on basis of the soiling level.



LOAD SENSOR:

Since the load sensor is only available in certain models it may not be available in your product. The load amount is not measured in products without a load sensor. The recommended amount of laundry load is displayed on the screen. The screen displays "Full Load" symbol for Cottons programme and similar programmes, "Half Load" symbol for Synthetics programme and similar programmes, and "Less Load" symbol for woolen programme and similar programmes.

Time display

Remaining time for the completion of the programme while it is running is displayed as "01:30" in hours and minutes format.



Programme time may differ from the values in section "4.6.3 Programme and consumption table" depending on the water pressure, water hardness and temperature, ambient temperature, amount and the type of laundry, auxiliary functions selected and the changes at the mains voltage.

4.6.13 End Time

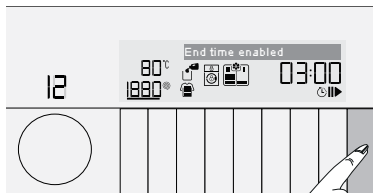
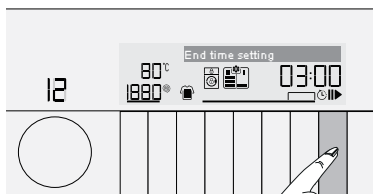

With the End Time function, the startup of the programme may be delayed up to 24 hours. After pressing End Time button, the programme's estimated ending time is displayed. If the End Time is adjusted, End Time indicator is illuminated. "End Time Setting" appears on the display.

In order for the End Time function to be activated and the programme to be completed at the end of the specified time, after the duration setting the Start indicator starts to lit. If you want to cancel End Time function, press End Time button until the End Time indicator turns off or press On / Off button to turn off and on the machine.



Do not use liquid detergents when you activate End Time function! There is the risk of staining of the clothes.

- 1 Open the loading door, place the laundry and put detergent, etc.
- 2 Select the washing programme, temperature, spin speed and, if required, the auxiliary functions.
- 3 Set the end time of your choice by pressing the **End Time** button. **End Time** indicator illuminates.
- 4 Press **Start / Pause** button. Time countdown starts. ":" symbol in the middle of the end time on the display starts flashing.



Additional laundry may be loaded during the **End Time** countdown period. At the end of the countdown, End Time indicator turns off, washing cycle starts and the time of the selected programme appears on the display.

When the **End Time** selection is completed, the time appears on the screen consists of end time plus the duration of the selected programme.

4.6.14 Starting the programme

- 1 Press **Start / Pause** button to start the programme.



- 2 Start indicator is lit to indicate that the programme is started. "Programme starts" appears on the display for "3" seconds.
- 3 Loading door is locked. "Locking Door" appears on the display when the door is being locked.
- 4 Programme step is indicated on the display.



4.6.15 Loading door lock

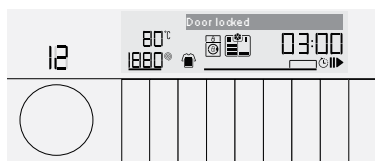

There is a locking system on the loading door of the machine that prevents opening of the door in cases when the water level is unsuitable.

"Door Locked" appears on the display when the loading door is locked. Lock indicator will be displayed.

4.6.16 Changing the selections after programme has started

Adding laundry after the programme has started:

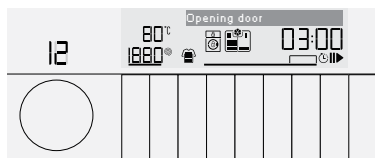

If the water level in the machine is suitable when you press Start / Pause button, "Opening door" will appear on the display.

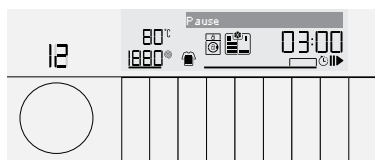

If the water level in the machine is not suitable when you press Start / Pause button, the display will show that the loading door is locked.

Switching the machine to pause mode:
Press the Start / Pause button to switch the machine to pause mode. The Start indicator disappears and Wait indicator will be lit and "Standby" text will be displayed.

Changing the programme selection after programme has started:

The programme change is not allowed when the current programme is running. If you turn the **Programme Selection** knob while the programme is running, "Switch to Standby" appears on the display. You can select the new programme after switching the current programme to pause mode.



The selected program starts anew.

Changing the auxiliary function, speed and temperature

Depending on the step the programme has reached, you can cancel or activate the auxiliary functions. See, "4.6.11 Auxiliary function selection".

You can also change the speed and temperature settings. See, "4.6.6 Temperature selection" and "4.6.7 Spin speed selection".



The loading door will not open if the water temperature in the machine is high or the water level is above the loading door baseline.

4.6.17 Child Lock

Use Child Lock function to prevent children from tampering with the machine. Thus you can avoid any changes in a running programme.



You can switch on and off the machine with **On / Off** button when the Child Lock is active. When you switch on the machine again, programme will resume from where it has stopped.

When the Child Lock is enabled, an audio warning will be given if the buttons are pressed. Audio warning will be canceled if the buttons are pressed 5 times consecutively. Only the warning on the display will remain active.

To activate the Child Lock:



1. Press and hold Auxiliary Function button 1 for 3 seconds. After the countdown as "Child Lock: 311-211-111" on the display is over, "Child Lock Enabled" appears on the display. You can release Auxiliary Function button 1 when this warning is displayed.



"Child Lock Enabled" appears on the display if you press any button when Child Lock is enabled.

To deactivate the child lock:

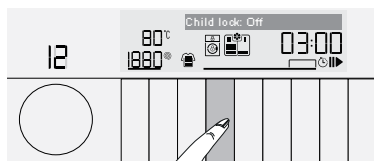

1. Press and hold Auxiliary Function button 1 for 3 seconds. After the countdown as "Child Lock: After the countdown as "Child Lock: 311-211-111" on the display is over, "Child Lock Disabled" appears on the display and Child lock indicator is lit.

4.6.18 Cancelling the programme

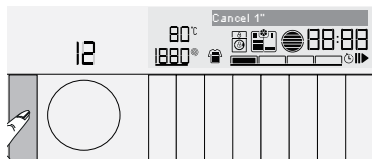

The programme is cancelled when the machine is turned off and on again. Press and hold On / Off button for 3 seconds. After the countdown as "Cancel: 311-211-11" on the display is over, the machine is switched off.



If you press On / Off button when the Child Lock is enabled, the programme will not be cancelled. You should cancel the Child Lock first. A countdown as "Standby 311-211-11" is displayed.

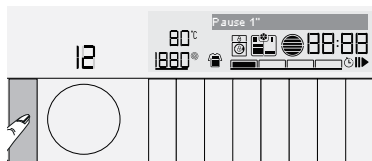

If you want to open the loading door after you have cancelled the programme but it is not possible to open the loading door since the water level in the machine is above the loading door baseline, then turn the Programme Selection knob to Pump+Spin programme and drain the water in the machine.

4.6.19 End of programme

"Laundry can be taken out" appears on the display when the programme is completed.

If you do not press any button for 10 minutes, the machine will switch to standby mode. Display and all indicators are turned off.

If you press any button or turn the **Programme Selection** knob when the machine is in standby mode, programme steps that are completed will appear on the display.

4.6.20 Favourite program setting

You can create a favorite programme by saving frequently used programme and other settings. Use this function when you want to select quickly the same settings you use for the laundry that you wash regularly.

Favorite programme will remain at the factory set programme until you make a new favorite programme setting.

To store a new favourite programme:

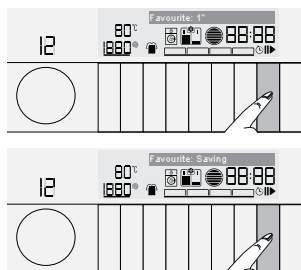

- 1 Select the desired programme, temperature, spin speed, soiling degree and auxiliary function.
- 2 Keep the **Favourite** button pressed for 3 seconds.
- 3 A countdown as "Favourite: 3 11-2 11-1 11" "Favourite: Saving" will be displayed.



If storing is not successful, "Favorite: not saved" appears on the display.

To select a favourite programme:

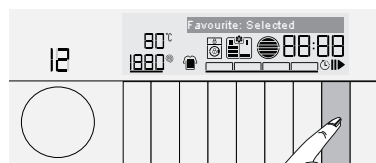

- 1 Press Favourite button. "Favorite selected" appears on the display.
- 2 Programme and other settings saved as favourite appear on the display.
- 3 Press Start / Pause button to start the Favourite programme.

4.6.21 Entering the settings menu

You can perform the following operations in Settings menu:

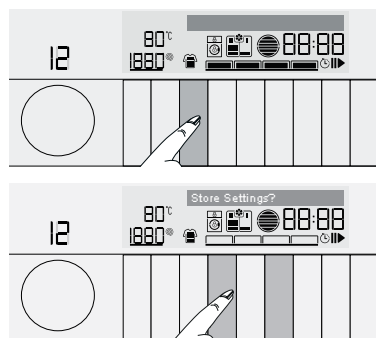

- Changing the language selection
- Changing the screen brightness setting
- Changing the volume level
- Restoring the factory settings

Adjustment of detergent amount

To enter Settings menu, press and hold Soiling Level Setting button for 3 seconds. "Sound setting" menu will appear.

To navigate the menus, use the 1st and 3rd auxiliary function buttons.

Changing the language selection

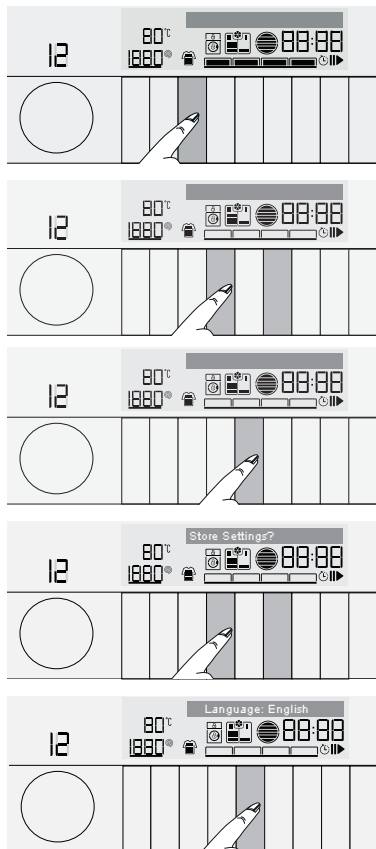

- 1 Press and hold Soiling Level Setting button for 3 seconds to enter the Settings menu. Using the 1st and 3rd Auxiliary Function buttons open the "Language" menu.
- 2 Press the 2nd auxiliary function button until the desired language appears on the display.
- 3 When the desired language appears on the display press one of the 1st and 3rd Auxiliary Function buttons. "Save setting?" will be prompted.
- 4 Pressing the second auxiliary function button will save the settings.

Changing the screen brightness setting

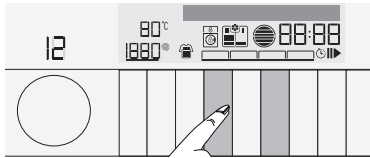

- 1 Press and hold Soiling Level Setting button for 3 seconds to enter the Settings menu. Using the 1st and 3rd Auxiliary Function buttons open the "Brightness" menu.

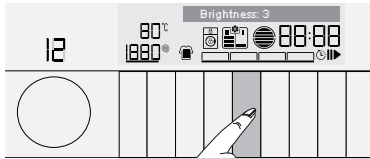

- 2 Press the 2nd auxiliary function button until the desired brightness level appears on the brightness menu.

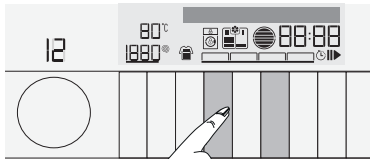

- 3 When the desired brightness appears on the display press one of the 1st and 3rd Auxiliary Function buttons. The desired brightness level will be saved.

Adjusting the volume level

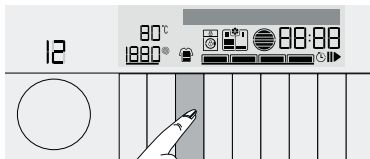

- 1 Press and hold Soiling Level Setting button for 3 seconds to enter the Settings menu. Using the 1st and 3rd Auxiliary Function buttons open the "Volume Level" menu.

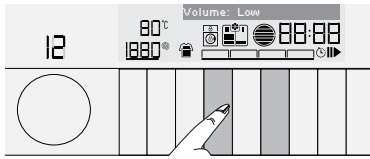

- 2 The Volume setting can be High or Low. The menu will be opened with the last selected level. Press the 2nd auxiliary function button until the desired level appears. The desired volume level will be saved.

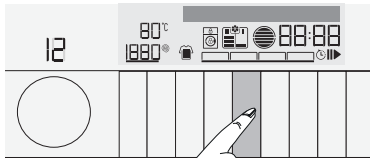
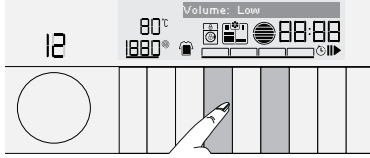

Restoring the factory settings

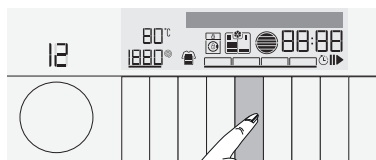
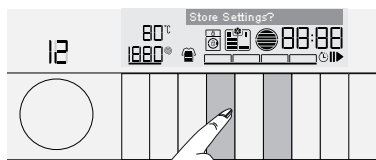
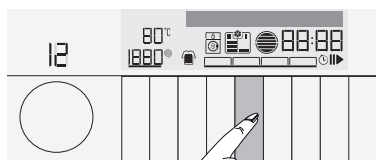
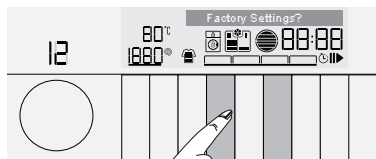
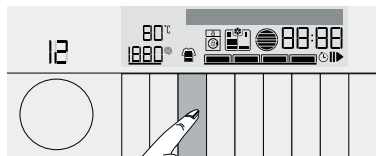

- Display language will return to the first language you selected when you have operated your machine for the first time:
- Brightness is set to maximum level,
- The volume will be set to high level.
- Favourite programme selection is returned to factory settings.

- 1 Press and hold Soiling Level Setting button for 3 seconds to enter the Settings menu. Use the 1st and 3rd Auxiliary Function buttons to open the "Factory Settings" menu.
- 2 Press the 2nd auxiliary function button to restore the factory settings.
- 3 To restore the factory settings press one of the 1st and 3rd Auxiliary Function buttons. "Save setting?" will be prompted.
- 4 Pressing the second auxiliary function button will save the settings.

Settings menu for liquid detergent dosing:

Changing the detergent amount:

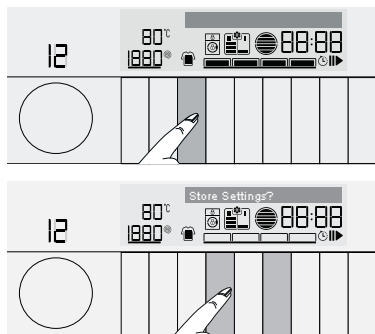

- The user can change the amount of detergent depending on the properties of the liquid detergent that is used.
- Enter the settings menu, select 'Detergent amount <ml>' and increase or decrease the amount. The amount can be changed between 20 ml and 130 ml.
- The amount of detergent that will be used during washing will be determined automatically based on this value and the selected programme, amount of laundry and level of soiling.

Changing the softener amount:

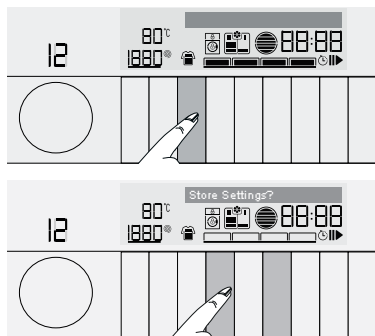

- The user can change the amount of softener depending on the properties of the softener that is used.
- Enter the settings menu, select 'Softener amount <ml>' and increase or decrease the amount. The amount can be changed between 20 ml and 80 ml.
- The amount of softener that will be used during washing will be determined automatically based on this value and the selected programme and amount of laundry.
- If you don't want to use softener during washing, select 'Cancel' from the menu.

4.6.22 Your machine is equipped with a “Standby Mode”

In case of not starting any programme or waiting without making any other operation when the machine is turned on by On/Off button and while it is in selection step or if no other operation is performed approximately 2 minutes after the programme you selected has come to an end, your machine will automatically switch to energy saving mode. Brightness of indicator lights will decrease. Also, if your product is equipped with a display showing the programme duration, this display will completely turn off. In case of rotating the Programme Selection knob or pressing any button, lights and display will restore to their previous condition. Your selections made while exiting the energy saving mode may change. Check the appropriateness of your selections before starting the programme. Readjust if necessary. This is not a fault.

4.7 Maintenance and cleaning

Service life of product extends and frequently experienced problems will be reduced if it is cleaned at regular intervals.

4.7.1 Cleaning the detergent drawer

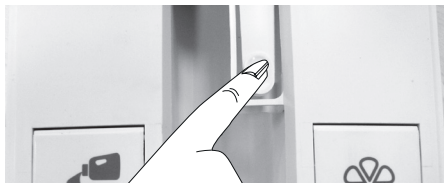

- Take out the detergent drawer.



- The apparatus found behind the drawer will be removed from its slot.
- The hole behind the detergent compartment that will be emptied is placed over a container.
- The apparatus is inserted into the slot found behind the detergent compartment.
- The detergent starts to flow to the container.
- Repeat the same process for softener.

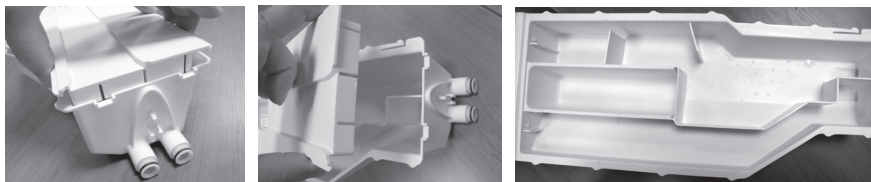

- Remove the top cover of the detergent drawer and wash inside of the drawer.
- After washing it, place the cover back to its location.
- Remove the top cover of the detergent drawer and wash inside of the drawer.
- After washing it, place the cover back to its location.
- Insert back the drawer.

4.7.2 Cleaning the loading door and the drum

For products with drum cleaning programme, please see Operating the product - Programmes.

For products without drum cleaning, follow the below steps **to clean the drum**:

Select **Additional Water** or **Extra Rinse** auxiliary functions. Use a Cottons programme without pre-wash. Set **the temperature to the level recommended on the drum cleaning agent which can be provided from authorized services**. Apply this procedure **without any laundry in the product**. Before starting the programme, put 1 pouch of special drum cleaning agent (if the special agent could not be supplied, put max. 100 g of powder anti-limescale) into the main wash detergent compartment (compartment no. „2“). If the anti-limescale is in tablet form, put only one tablet into the main wash compartment no. „2“. Dry the inside of the bellow with a clean piece of cloth after the programme has come to an end.



Repeat Drum Cleaning process in every 2 months.

Use an anti-limescale suitable for the washing machines.

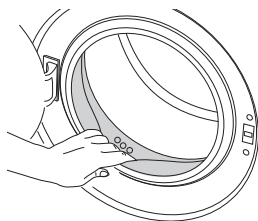

After every washing make sure that no foreign substance is left in the drum.

If the holes on the bellow shown in the figure is blocked, open the holes using a toothpick.

Foreign metal substances will cause rust stains in the drum. Clean the stains on the drum surface by using cleaning agents for stainless steel.

Never use steel wool or wire wool. These will damage the painted, chromated and plastic surfaces.

4.7.3 Cleaning the body and control panel

Wipe the body of the product with soapy water or non-corrosive mild gel detergents as necessary, and dry with a soft cloth.

Use only a soft and damp cloth to clean the control panel.

4.7.4 Cleaning the water intake filters

There is a filter at the end of each water intake valve at the rear of the product and also at the end of each water intake hose where they are connected to the tap. These filters prevent foreign substances and dirt in the water to enter the product. Filters should be cleaned as they do get dirty.

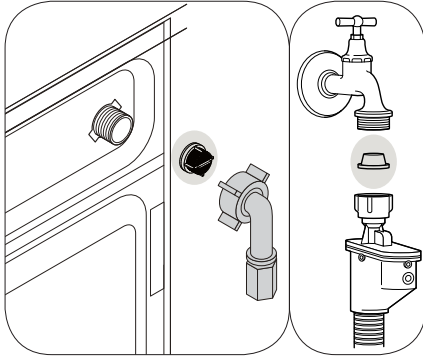

1. Close the taps.
2. Remove the nuts of the water intake hoses to access the filters on the water intake valves. Clean them with an appropriate brush. If the filters are too dirty, remove them from their places with a pliers and clean in this way.
3. Take out the filters on the flat ends of the water intake hoses together with the gaskets and clean thoroughly under running water.
4. Replace the gaskets and filters carefully and tighten their nuts by hand.

4.7.5 Draining remaining water and cleaning the pump filter

The filter system in your product prevents solid items such as buttons, coins and fabric fibers clogging the pump impeller during draining of washing water. Thus, the water will be drained without any problem and the service life of the pump will extend.

If the product fails to drain water inside it, the pump filter is clogged. Filter must be cleaned whenever it is clogged or in every 3 months. Water must be drained off first to clean the pump filter.

In addition, prior to transporting the product (e.g., when moving to another house) water should be drained completely.



CAUTION: Foreign substances left in the pump filter may damage your product or may cause noise problem.

CAUTION: In regions where freezing is possible, the tap must be closed, system hose must be removed and the water inside the product must be drained when the product is not in use.

CAUTION: After each use, turn off the tap to which the mains hose is connected.

In order to clean the dirty filter and discharge the water:

- 1 Unplug the product to cut off the supply power.



CAUTION: Temperature of the water inside the product may rise up to 90 °C. To avoid the risk of scalding, clean the filter after the water inside the product is cooled down.

2. Open the filter cover.

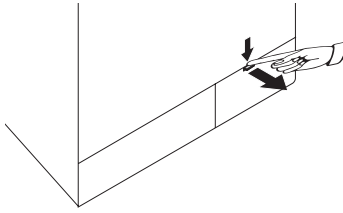

If the filter cap is composed of two pieces, press the tab on the filter cap downwards and pull the piece out towards yourself.

3 Follow the below procedures in order to drain water.

If the product has an emergency water draining hose, in order to drain the water:

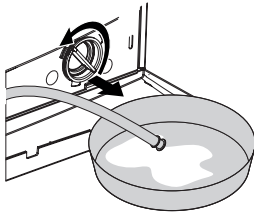

- a Pull the emergency draining hose out from its seat.
- b Place a large container at the end of the hose. Drain the water into the container by pulling out the plug at the end of the hose. When the container is full, block the inlet of the hose by replacing the plug. After the container is emptied, repeat the above procedure to drain the water in the product completely.
- c When draining of water is finished, close the end by the plug again and fix the hose in its place.
- d Turn and remove the pump filter.

4 Clean any residues inside the filter as well as fibers, if any, around the pump impeller region.

5. Replace the filter.

6. If the filter cap is composed of two pieces, close the filter cap by pressing on the tab. If it is one piece, seat the tabs in the lower part into their places first, and then press the upper part to close.

5 Troubleshooting

Problem	Reason	Solution
Programme does not start after closing the door	Start / Pause / Cancel button was not pressed.	• *Press the Start / Pause / Cancel button.
	The programme will not start if the liquid detergent container is empty or if the detergent amount in it is not enough.	• Fill the liquid detergent container.
Programme cannot be started or selected.	The product may have switched to self protection mode due to a supply problem (line voltage, water pressure, etc.).	• Press and hold On / Off button for 3 seconds to reset the product to factory settings. (See. Cancelling the programme")
Water inside the product.	Some water might have remained in the product due to the quality control processes in the production.	• This is not a failure; water is not harmful to the product.
The product does not take water in.	Tap is turned off.	• Turn on the taps.
	Water inlet hose is bent or crushed.	• Reposition the hose.
	Water inlet filter is clogged.	• Clean the filter.
	Loading door may be open.	• Close the door.
The product does not drain water.	Water drain hose might be clogged or twisted.	• Clean or reposition the hose.
	Pump filter is clogged.	• Clean the pump filter.
Product vibrates or makes noise.	Product might be standing unbalanced.	• Steady the product by adjusting the feet.
	A hard substance might have entered into the pump filter.	• Clean the pump filter.
	Transportation safety bolts are not removed.	• Remove the transportation safety bolts.
	Laundry quantity in the product might be too little.	• Add more laundry to the product.
	Excessive laundry might be loaded in the product.	• Take out some of the laundry from the product or distribute the load by hand to balance it evenly in the product.
	Product might be leaning on a rigid item.	• Make sure that the product is not leaning on anything.
There is water leaking from the bottom of the product.	Water drain hose might be clogged or twisted.	• Clean or reposition the hose.
	Pump filter is clogged.	• Clean the pump filter.
Product stopped shortly after the programme started.	Machine might have stopped temporarily due to low voltage.	• Product will resume running when the voltage restores to the normal level.
Product directly discharges the water it takes in.	Draining hose might not be at adequate height.	• Connect the water draining hose as described in the operation manual.
No water can be seen in the product during washing.	Water is below the visible area of the door.	• This is not a failure. Environmentalist washing machines use less water.
Loading door cannot be opened.	The cover lock is activated due to the water level inside the product.	• Drain the water by running the Pump or Spin programme.
	Product is heating up the water or it is at the spinning cycle.	• Wait until the programme completes.
	Child lock is engaged. Door lock will be deactivated a couple of minutes after the programme has come to an end.	• Wait for a couple of minutes for deactivation of the door lock.

Problem	Reason	Solution
Washing takes longer time than specified in the manual. (*)	Water pressure is low.	<ul style="list-style-type: none"> Product waits until taking in adequate amount of water to prevent poor washing quality due to the decreased amount of water. Therefore, the washing time extends.
	Voltage might be low.	<ul style="list-style-type: none"> Washing time is prolonged to avoid poor washing results when the supply voltage is low.
	Input temperature of water might be low.	<ul style="list-style-type: none"> Required time to heat up the water extends in cold seasons. Also, washing time can be lengthened to avoid poor washing results.
	Number of rinses and/or amount of rinse water might have increased.	<ul style="list-style-type: none"> Product increases the amount of rinse water when good rinsing is needed and adds an extra rinsing step if necessary.
	Excessive foam might have occurred and automatic foam absorption system might have been activated due to too much detergent usage.	<ul style="list-style-type: none"> Use recommended amount of detergent.
Programme time does not countdown. (On models with display) (*)	Timer may stop during water intake.	<ul style="list-style-type: none"> Timer indicator will not countdown until the product takes in adequate amount of water. The product will wait until there is sufficient amount of water to avoid poor washing results due to lack of water. Timer indicator will resume countdown after this.
	Timer may stop during heating step.	<ul style="list-style-type: none"> Timer indicator will not countdown until the product reaches the selected temperature.
	Timer may stop during spinning step.	<ul style="list-style-type: none"> Automatic unbalanced load detection system might be activated due to the unbalanced distribution of the laundry in the product.
Programme time does not countdown. (*)	There might be unbalanced load in the product.	<ul style="list-style-type: none"> Automatic unbalanced load detection system might be activated due to the unbalanced distribution of the laundry in the product.
Product does not switch to spinning step. (*)	There might be unbalanced load in the product.	<ul style="list-style-type: none"> Automatic unbalanced load detection system might be activated due to the unbalanced distribution of the laundry in the product.
	The product will not spin if water is not drained completely.	<ul style="list-style-type: none"> Check the filter and the draining hose.
	Excessive foam might have occurred and automatic foam absorption system might have been activated due to too much detergent usage.	<ul style="list-style-type: none"> Use recommended amount of detergent.
Washing performance is poor: Laundry turns Grey. (**)	Insufficient amount of detergent has been used over a long period of time.	<ul style="list-style-type: none"> Use the recommended amount of detergent appropriate for water hardness and the laundry.
	Washing was made at low temperatures for a long time.	<ul style="list-style-type: none"> Select the proper temperature for the laundry to be washed.
	Insufficient amount of detergent is used with hard water.	<ul style="list-style-type: none"> Using insufficient amount of detergent with hard water causes the soil to stick on the cloth and this turns the cloth Grey in time. It is difficult to eliminate Greying once it happens. Use the recommended amount of detergent appropriate for water hardness and the laundry.
	Excessive amount of detergent was used.	<ul style="list-style-type: none"> Use the recommended amount of detergent appropriate for water hardness and the laundry.

Problem	Reason	Solution
Washing performance is poor: Stains persist or the laundry is not whitened. (**)	Insufficient amount of detergent is used.	<ul style="list-style-type: none"> Use the recommended amount of detergent appropriate for water hardness and the laundry.
	Excessive laundry was loaded in.	<ul style="list-style-type: none"> Do not load the product in excess. Load with amounts recommended in the "4.6.3 Programme and consumption table".
	Wrong programme and temperature were selected.	<ul style="list-style-type: none"> Select the proper programme and temperature for the laundry to be washed.
	Wrong type of detergent is used.	<ul style="list-style-type: none"> Use original detergent appropriate for the product.
	Excessive amount of detergent was used.	<ul style="list-style-type: none"> Put the detergent in the correct compartment. Do not mix the bleaching agent and the detergent with each other.
Washing performance is poor: Oily stains appeared on the laundry. (**)	Regular drum cleaning is not applied.	<ul style="list-style-type: none"> Clean the drum regularly. For this procedure, please see "4.7.2 Cleaning the loading door and the drum".
Washing performance is poor: Clothes smell unpleasantly. (**)	Odours and bacteria layers are formed on the drum as a result of continuous washing at lower temperatures and/or in short programmes.	<ul style="list-style-type: none"> Leave the detergent drawer as well as the loading door of the product ajar after each washing. Thus, a humid environment favorable for bacteria cannot occur in the machine.
Colour of the clothes faded. (**)	Excessive laundry was loaded in.	<ul style="list-style-type: none"> Do not load the product in excess.
	Detergent in use is damp.	<ul style="list-style-type: none"> Keep detergents closed in an environment free of humidity and do not expose them to excessive temperatures.
	A higher temperature is selected.	<ul style="list-style-type: none"> Select the proper programme and temperature according to the type and soiling degree of the laundry.
It does not rinse well.	The amount, brand and storage conditions of the detergent used are inappropriate.	<ul style="list-style-type: none"> Use a detergent appropriate for the washing machine and your laundry. Keep detergents closed in an environment free of humidity and do not expose them to excessive temperatures.
	Detergent is put in the wrong compartment.	<ul style="list-style-type: none"> If detergent is put in the prewash compartment although prewash cycle is not selected, the product can take this detergent during rinsing or softener step. Put the detergent in the correct compartment.
	Pump filter is clogged.	<ul style="list-style-type: none"> Check the filter.
	Drain hose is folded.	<ul style="list-style-type: none"> Check the drain hose.
Laundry became stiff after washing. (**)	Insufficient amount of detergent is used.	<ul style="list-style-type: none"> Using insufficient amount of detergent for the water hardness can cause the laundry to become stiff in time. Use appropriate amount of detergent according to the water hardness.
	Detergent is put in the wrong compartment.	<ul style="list-style-type: none"> If detergent is put in the prewash compartment although prewash cycle is not selected, the product can take this detergent during rinsing or softener step. Put the detergent in the correct compartment.
	Detergent might be mixed with the softener.	<ul style="list-style-type: none"> Do not mix the softener with detergent. Wash and clean the dispenser with hot water.
Laundry does not smell like the softener. (**)	Detergent is put in the wrong compartment.	<ul style="list-style-type: none"> If detergent is put in the prewash compartment although prewash cycle is not selected, the product can take this detergent during rinsing or softener step. Wash and clean the dispenser with hot water. Put the detergent in the correct compartment.
	Detergent might be mixed with the softener.	<ul style="list-style-type: none"> Do not mix the softener with detergent. Wash and clean the dispenser with hot water.

Problem	Reason	Solution
Detergent residue in the detergent drawer. (**)	Detergent is put in wet drawer.	• Dry the detergent drawer before putting in detergent.
	Detergent has become damp.	• Keep detergents closed in an environment free of humidity and do not expose them to excessive temperatures.
	Water pressure is low.	• Check the water pressure.
	The detergent in the main wash compartment got wet while taking in the prewash water. Holes of the detergent compartment are blocked.	• Check the holes and clean if they are clogged.
	There is a problem with the detergent drawer valves.	• Call an Authorised Service Agent.
	Detergent might be mixed with the softener.	• Do not mix the softener with detergent. Wash and clean the dispenser with hot water.
Too much foam forms inside the product. (**)	Regular drum cleaning is not applied.	• Clean the drum regularly. For this procedure, please see "4.7.2 Cleaning the loading door and the drum".
	Improper detergents for the washing machine are being used.	• Use detergents appropriate for the washing machine.
	Excessive amount of detergent is used.	• Use only sufficient amount of detergent.
	Detergent was stored under improper conditions.	• Store detergent in a closed and dry location. Do not store in excessively hot places.
	Some meshed laundry such as tulle may foam too much because of their texture.	• Use smaller amounts of detergent for this type of item.
	Detergent is put in the wrong compartment.	• Put the detergent in the correct compartment.
Foam is overflowing from the detergent drawer.	Softener is being taken early by the product.	• There may be problem in the valves or in the detergent dispenser. Call an Authorised Service Agent.
	Too much detergent is used.	• Mix 1 tablespoonful softener and ½ l water and pour into the main wash compartment of the detergent drawer.
Laundry remains wet at the end of the programme. (*)	Excessive foam might have occurred and automatic foam absorption system might have been activated due to too much detergent usage.	• Put detergent into the product suitable for the programmes and maximum loads indicated in the "4.6.3 Programme and consumption table". When you use additional chemicals (stain removers, bleaches and etc), reduce the amount of detergent.
		• Use recommended amount of detergent.
(*) The product does not switch to spinning step when the laundry is not evenly distributed in the drum to prevent any damage to the product and to its surrounding environment. Laundry should be rearranged and re-spun.		
(**) Regular drum cleaning is not applied. Clean the drum regularly. See 4.7.2		
	CAUTION: If you cannot eliminate the problem although you follow the instructions in this section, consult your dealer or an Authorised Service Agent. Never try to repair a nonfunctional product yourself.	

GRUNDIG NORDIC
GLYNITVEIEN 25, PB 234
1402 SKI, NORWAY

GRUNDIG

www.grundig.com