



DISHWASHER USER INSTRUCTIONS

GNV 5E036 1A

ENG

www.grundig.com

FOR A GOOD REASON

GRUNDIG

DISHWASHER

USER INSTRUCTIONS

GNV 5E036 IA

ENG

Please read this user manual first!

Dear Customer,

Thank you for preferring a Grundig product. We hope that you get the best results from your product which has been manufactured with high quality and state-of-the-art technology. Therefore, please read this entire user manual and all other accompanying documents carefully before using the product and keep it as a reference for future use. If you handover the product to someone else, give the user manual as well. Follow all warnings and information in the user manual.

Remember that this user manual is also applicable for several other models. Differences between models will be identified in the manual.

Explanation of symbols

Throughout this User Manual the following symbols are used:

	Important information or useful hints about usage.
	Warning for hazardous situations with regard to life and property.
	Warning for electric shock.
	Packaging materials of the product are manufactured from recyclable materials in accordance with our National Environment Regulations.

Do not dispose of the packaging materials together with the domestic or other wastes. Take them to the packaging material collection points designated by the local authorities.

This product was manufactured using the latest technology in environmentally friendly conditions.

CONTENTS

1 INSTRUCTIONS FOR SAFETY AND ENVIRONMENT 4

General safety	4
Intended use	4
Children's safety	5
Disposing of packaging material	5
Transportation of the product	6
Compliance with WEEE Directive and Disposing of the Waste Product	6
Compliance with RoHS Directive	6
Package information	6

2 DISHWASHER 7

Overview	7
Fan drying system	8
Technical specifications	8

3 INSTALLATION 9

Appropriate installation location	9
Connecting water supply	9
Connection to the drain	10
Adjusting the feet	10
WaterProtect+	11
Electrical connection	11
Initial use	11

4 PREPARATION 12

Tips for energy saving	12
Water softening system	12
Adjusting the water softening system	12
Adding salt	14
Detergent	14
Adding Liquid/Gel Detergent and Rinse Aid	15
Powder Detergents	17
Tablet detergents	18
Cutlery basket	22
Cutlery basket	22
Collapsible lower basket tines	23
Collapsible lower basket tines	23
Tray Wash Supports	24
SoftTouch Accessory	24
Lower Basket Glass Holder	24

Lower basket multipurpose / height adjustable service rack	25
Lower basket bottle wire	26
Upper basket height adjustable rack	26
Upper basket multipurpose service rack	26
Adjusting the height of the upper basket	27
Collapsible upper basket wires	28
Height setting with empty basket	28
Ceiling cutlery basket	29
Ceiling cutlery basket	29

5 OPERATING THE PRODUCT 30

Programme Selection / Programme Cancel key	31
Function Keys	31
Preparing the machine	31
Programme selection	31
Auxiliary functions	34
Scheduling the washing time	36
Starting the programme	37
Cancelling the programme	37
Adjusting the amount of rinse aid	38
Salt indicator (S)	38
Rinse Aid indicator (☼)	38
End of programme	38
Water cut-off warning	38
Overflowing warning	39

6 HOMEWHIZ FUNCTION 40

HomeWhiz Setup and User Account Settings	40
--	----

7 MAINTENANCE AND CLEANING 44

Cleaning the outer surface of the product	44
Cleaning the interior of the machine	44
Cleaning the filters	44
Cleaning the hose filter	45
Cleaning the impellers	46
Lower impeller assembly	46
Upper impeller	46

8 TROUBLESHOOTING 47

1 INSTRUCTIONS FOR SAFETY AND ENVIRONMENT

This section contains safety instructions that will help to get protected from risk of personal injury or property damage. Failure to follow these instructions shall void all warranties.

General safety

- Never place the product on a carpet-covered floor; otherwise, lack of airflow beneath the product will cause electrical parts to overheat. This will cause problems with your product.
- Do not operate the product if the power cable / plug is damaged! Call the Authorised Service Agent.
- Connect the product to a grounded outlet protected by a fuse complying with the values in the "Technical specifications" table. Do not neglect to have the grounding installation made by a qualified electrician. The manufacturer shall not be liable for any damages that will arise when the product is used without grounding in accordance with the local regulations.
- The water supply and draining hoses must be securely fastened and remain undamaged.
- Unplug the product when not in use.
- Never wash the product by spreading or pouring water onto it! There is the risk of electric shock!
- Never touch the plug with wet hands! Never unplug by pulling on the cable, always pull out by grabbing the plug.
- The product must be unplugged during installation, maintenance, cleaning and repairing procedures.
- Always have the installation and repairing procedures carried out by the Authorised Service Agent. Manufacturer shall not be held liable for damages that may arise from procedures carried out by unauthorised persons.
- Never use chemical solvents in the product. They bring forth the risk of explosion.
- When you pull the upper and lower baskets out completely, the door of the product will bear all the weight of the baskets. Do not put other loads on the door; otherwise, the product may tilt.
- Never leave the door of the product open apart from loading and unloading procedures.
- Do not to open the door of the product when it is running unless necessary. Be careful for the rush of hot steam when you open the door.

Intended use

- This product has been designed for domestic use.
- It must be used to do the domestic type dishes only.

- This appliance is intended to be used in household and similar applications such as:
 - Staff kitchen areas in shops, offices and other working environments;
 - Farm houses;
 - By clients in hotels, motels and other residential type environments;
 - Bed and breakfast type environments
- Only dishwasher safe detergents, rinse aids and additives must be used.
- The manufacturer waives any responsibility arisen from incorrect usage or transportation.
- The service life of your product is 10 years. During this period, original spare parts will be available to operate the product properly.
- This appliance can be used by children aged from 8 years and above and persons with reduced physical, sensory or mental capabilities or lack of experience and knowledge if they have been given supervision or instruction concerning use of the appliance in a safe way and understand the hazards involved. Children shall not play with the appliance. Cleaning and user maintenance shall not be made by children without supervision.

Children's safety

- Electrical products are dangerous for the children. Keep children away from the product when it is in use. Do not let them to tamper with the product.
- Do not forget to close the door of the product when leaving the room where it is located.
- Store all detergents and additives in a safe place away from the reach of the children.

Disposing of packaging material

Packaging materials are dangerous to children. Keep packaging materials in a safe place away from reach of the children. Packaging materials of the product are manufactured from recyclable materials. Dispose of them properly and sort in accordance with recycled waste instructions. Do not dispose of them with normal domestic waste.

Transportation of the product



If you need to move the product, do it in upright position and hold from the rear side. Slanting the product onto its front side may cause the electronic parts in it get wet and damaged.

1. Unplug the product before transporting it.
2. Remove water drainage and water supply connections.
3. Drain the remaining water in the product completely.

Compliance with WEEE Directive and Disposing of the Waste Product



This product complies with EU WEEE Directive (2012/19/EU). This product bears a classification symbol for waste electrical and electronic equipment (WEEE). This product has been manufactured with high quality parts and materials which can be reused and are suitable for recycling. Do not dispose of the waste product with normal domestic and other wastes at the end of its service life. Take it to the collection center for the recycling of electrical and electronic equipment. Please consult your local authorities to learn about these collection centers.

Compliance with RoHS Directive

The product you have purchased complies with EU RoHS Directive (2011/65/EU). It does not contain harmful and prohibited materials specified in the Directive.

Package information

Packaging materials of the product are manufactured from recyclable materials in accordance with our National Environment Regulations. Do not dispose of the packaging materials together with the domestic or other wastes. Take them to the packaging material collection points designated by the local authorities.

2 DISHWASHER

Overview

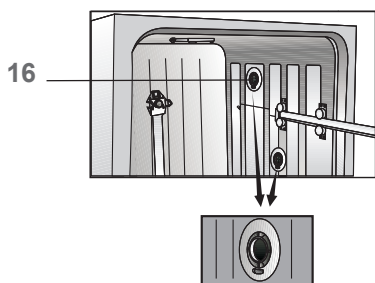
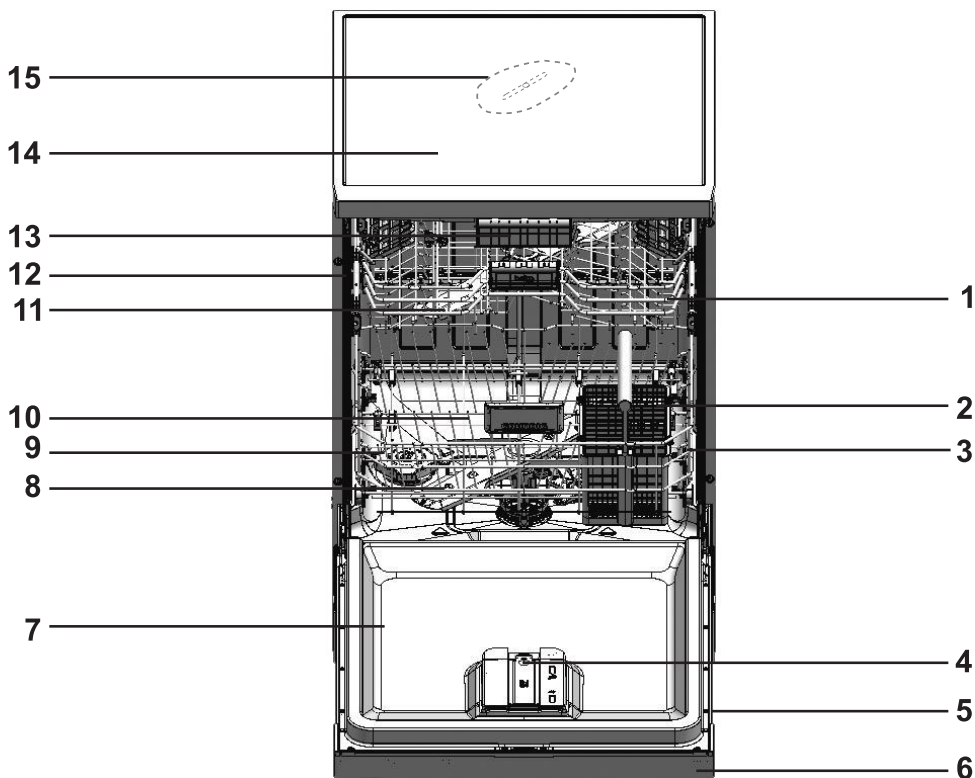

1. Upper basket
2. Cutlery basket
3. Lower basket
4. Automatic Liquid/Gel Detergent and Rinse Aid Dosing System
5. Type Label
6. Control panel
7. Door
8. Lower impeller
9. Salt reservoir lid
10. Filters
11. Upper impeller
12. Upper basket rail
13. Upper cutlery basket (depends on model)
14. Upper table (depends on model)
15. Ceiling impeller (depends on model)
16. Fan drying system (depends on model)

Technical specifications

CE Compliance to standards and test data / EC declaration of conformity

This product complies with the following EU directives;
Development, production and sales stages of this product comply with the safety rules included in all pertaining European Community regulations.

2014/35/EU, 2014/30/EU, 93/68/EC, IEC 60436/DIN 44990, EN 50242

Power input	220-240 V, 50 Hz (see rating label)
Total power consumption	1800-2100 W (see rating label)
Heater power consumption	1800 W (see rating label)
Total current (depends on the model)	10 A (see rating label)
Drain pump power consumption	30 W (see rating label)
Water pressure	0.3 - 10 bar (= 3 - 100 N/cm ² = 0.01-1.0 Mpa)



Technical specifications may be changed without prior notice to improve the quality of the product.



Figures in this manual are schematic and may not match the product exactly.



Values stated on the markings of the product or in the printed documents accompanying the product are obtained in the laboratory on basis of the relevant standards. Depending on operational and environmental conditions of the product, these values may vary.

Fan drying system

(depends on model)

Fan drying system ensures efficient drying of your dishes.

It is normal to hear a different sound than that of washing cycle during fan operation.

Note for test institutions:

Data required for performance tests shall be provided upon request. Requests can be e-mailed to the following address:

dishwasher@standardloading.com

Do not forget to provide the code, stock and serial numbers of the product to be tested in your request e-mail along with your contact information. Code, stock and serial numbers of the product may be found on the type label attached to the side wall of the door.

3 INSTALLATION

Refer to the nearest Authorised Service Agent for installation of your product. To make the product ready for use, make sure that the electricity, tap water supply and water drainage systems are appropriate before calling the Authorised Service Agent. If they are not, call a qualified technician and plumber to have any necessary arrangements carried out.



Preparation of the location and electrical, tap water and waste water installations at the place of installation is the customer's responsibility.



Installation and electrical connections must be carried out by the Authorised Service Agent. Manufacturer shall not be held responsible for damages arising from processes carried out by unauthorised persons.



Prior to installation, visually check if the product has any defects on it. If so, do not have it installed. Damaged products cause risks for your safety.



Make sure that the water inlet and discharge hoses are not folded, pinched or crushed while pushing the product into its place after installation or cleaning procedures.

When placing the product, pay attention not to damage the floor, walls, piping, etc. Do not hold the product by its door or panel to move it.

Appropriate installation location

- Place the product on a solid and flat floor that has sufficient load carrying capacity! The product must be installed on a flat surface in order for the door to be closed comfortably and securely.
- Do not install the product at places where temperature may fall below 0°C.
- Place the product at least 1 cm away from the edges of other furniture.
- Place the product on a rigid floor. Do not place it on a long pile rug or similar surfaces.



Do not place the product on the power cable.

- Make sure that you select a location that will allow you to load and unload the dishes in a fast and comfortable manner.
- Install the product in a place close to the tap and the drain hole. Select the installation location by considering that it will not be changed after the connections are made.

Connecting water supply



We recommend attaching a filter on the house/apartment supply water inlet to protect the machine from damages that may arise from impurities (sand, dirt, rust, etc.) coming from the urban water supply system or from your own water system as well as to prevent complaints such as yellowing or sludge accumulation at the end of washing.

Permitted water temperature: up to 25 °C

The dishwasher may not be connected to open warm water devices or flow-through water heaters.

- Do not use old or used water inlet hose on the new product. Use the new water inlet hose supplied with the product.
- Connect the water inlet hose directly to the water tap. Pressure coming from the tap should be minimum 0.3 and maximum 10 bars. If the water pressure exceeds 10 bars, a pressure relief valve should be installed in between.
- Open the taps completely after making the connections to check for water leaks.

i

Use a screw-on hose connector to connect the water inlet hose to a water tap with a 3/4 inch external thread. If required, use a filter insert to filter deposits from the pipes.

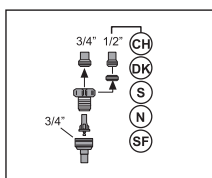
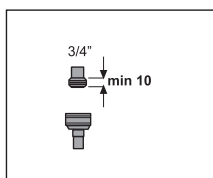

!

For your safety, close the water inlet tap completely after the washing programme is over.

Connection to the drain

Water discharge hose can directly be connected to the drain hole or sink's drainage. The length of this connection must be min. 50 cm and max. 100 cm from the floor. A discharge hose longer than 4 meters causes dirty washing.

Attach the water discharge hose to the drainpipe without bending it. Tightly fix the water discharge hose to the drainpipe in order to prevent any dislocation of the water discharge hose during operation of the product.

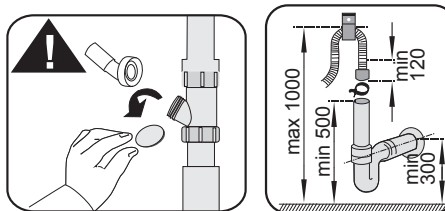
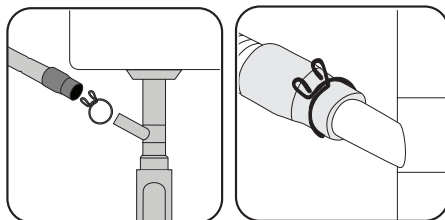

i

Drainpipe must be connected to the sewage system and it should not be connected to any surface water.

Adjusting the feet

If the door of the product cannot be closed properly or if the product swings when you push it slightly, then you need to adjust the feet of the product. Adjust the feet of the product as illustrated in the installation manual supplied with the product.

!

Dishwashers door must be aligned properly otherwise hot steam can escape! Danger of serious burns, other injury or may damage furniture.

WaterProtect+

(depends on model)

The WaterProtect+ system protects against water leaks that may occur at the hose inlet. Water contact with the valve box of the system must be avoided to prevent damage to the electrical system. If the WaterProtect+ system is damaged, unplug the product and call the Authorised Service Agent.



As the hose set contains electrical connections and assemblies, never shorten or lengthen the hose with extension hoses.

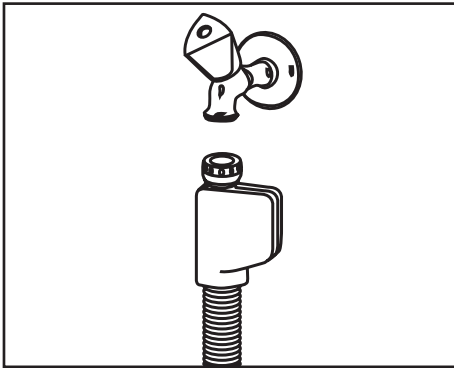

Electrical connection

Connect the product to a grounded outlet protected by a fuse complying with the values in the "Technical specifications" table. The manufacturer shall not be liable for any damages that will arise when the product is used without grounding in accordance with the local regulations.

- Connection must comply with national regulations.
- Power cable plug must be within easy reach after installation.



Unplug the product after the washing programme is over.

- The voltage and allowed fuse or breaker protection are specified in the "Technical specifications" section. If the current value of the fuse or breaker in the house is less than 16 Amps, have a qualified electrician install a 16 Amp fuse.
- The specified voltage must be equal to your mains voltage.
- Do not make connections via extension cables or multi-plugs.



Damaged power cables must be replaced by the Authorised Service Agent.



If your dishwasher is equipped with internal illumination, lamp should only be replaced by the Authorised Service Agent in case of failures that may occur on the lamp.



If the product has a failure, it should not be operated unless it is repaired by the Authorised Service Agent! There is the risk of electric shock!

Initial use

Before starting to use the product, make sure that all preparations are made in accordance with the instructions in sections "Important safety instructions" and "Installation".

- To prepare the product to do the dishes, perform first operation in the shortest programme with detergent while the machine is empty. During the initial use, fill the salt reservoir with 1 litre of water prior to filling it with salt.



There might be a small amount of water left in the product after factory quality control tests. This has no harm on the product.

4 PREPARATION

Tips for energy saving

Following information will help you use the product in an ecological and energy-efficient manner.

Wipe away any coarse food remnants on the dishes before putting them in the product.

Operate the product after filling it completely.

When selecting a programme, consider the table of "Programme data and average consumption values".

Do not put more detergent than suggested on the detergent package.

Water softening system

The product is equipped with a water softening system which reduces the hardness of incoming water. This system softens the supply water to a level that will allow washing the dishes with the required quality.

Dishwasher salt is used for this purpose.

Adjusting the water softening system

Cleaning, rinsing and drying performance of your dishwasher will increase when water softening system is adjusted properly.

Adjust the new water hardness level according to the Water hardness level instruction in this booklet.

Preparation

Use the test strip supplied with the product according to the steps given below to determine hardness level of your supply water.

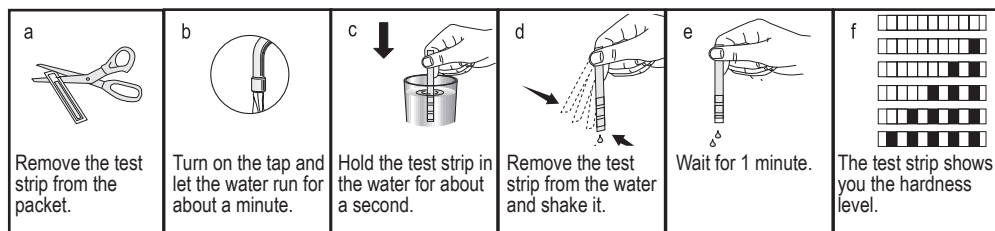

After determining hardness level of the supply water:

1. After switching on your machine, long press the Menu key
2. Press the settings menu key for 3 seconds to enter the Settings Menu.
3. Using <- and +> keys, proceed until the water hardness setting indicator becomes on ("r" position will be displayed).
4. Using the Selection key, adjust water hardness level according to the hardness of the supply water. For correct setting please see "Water hardness level setting table".
5. Press the Menu key to exit the settings menu. Your setting will be saved automatically.

Water hardness level adjustment table

Hardness Level	English Water Hardness °dE	German Water Hardness °dH	French Water Hardness °dF	Water Hardness Level Indicator
Level 0 	0-5	0-4	0-8	Press the Selection key to switch the water hardness level to position 1. (r1)
Level 1 	6-9	5-7	9-13	
Level 2 	10-15	8-12	14-22	Press the Selection key to switch the water hardness level to position 2. (r2)
Level 3 	16-19	13-15	23-27	Press the Selection key to switch the water hardness level to position 3. (r3)
Level 4 	20-24	16-19	28-34	Press the Selection key to switch the water hardness level to position 4. (r4)
Level 5 	25-62	20-50	35-90	Press the Selection key to switch the water hardness level to position 5. (r5)

If the hardness level of the supply water is above 90 °dF or if you are using well water, then it is recommended to use water purification devices and special filters.

Since your machine is equipped with an Automatic Water Hardness Detection System, appropriate salt should be put in the dishwasher when "Salt indicator" illuminates.

If salt is not put in the machine, the Automatic Water Hardness Detection System will not work properly.



If your machine is equipped with "Automatic Water Hardness Detection System", water hardness adjustment will be made by the service/user as standard during first installation. If you move your house, your machine will automatically perform water hardness level adjustment according to the water hardness in the new place you have moved in.



Adjust the water softness level according to the "Water hardness level instruction" supplied with your machine.

Adding salt



Use only special softening salts produced particularly for the dishwashers in your machine.

1. First take the lower basket out to add softening salt.
2. Turn the salt reservoir lid counter-clockwise to open it (A).

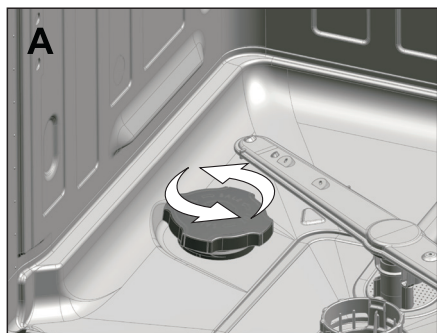

3. Add 1 litre of water to salt reservoir of your machine only in initial use.
4. Add salt to the salt compartment. To speed up dissolution rate of salt in water, stir it with a spoon.



You can put about 2 kg of softening salt into the salt reservoir.

5. Replace the lid and tighten it when the reservoir is full.



You need to add salt right before starting the machine. Thus, the overflowing salty water will be flushed immediately, preventing the risk of corrosion in machine. In cases where you would not start washing immediately, run your machine empty in the shortest program.



Since different salt brands in the market have different particle sizes and since the water hardness may vary, dissolution of the salt in water may take a couple of hours. Therefore, Salt Indicator remains on for a while after adding salt into the machine.

Detergent

You can use powder, tablet and liquid/gel detergent in the machine.



Only use the detergents produced particularly for use with dishwashers in the machine. We recommend you not to use detergents that contain chlorine and phosphate as they are harmful for the environment.

Your dishwasher is equipped with an Automatic Liquid/Gel Detergent Dosing System.

Thanks to this system, the amount of rinse aid and liquid/gel detergent required for the selected washing programme is adjusted automatically.



Please read the information given in section “Operating the Product” to activate or deactivate the Automatic Liquid/Gel Detergent Dosing adjustment.



When the Automatic Liquid/Gel Detergent function is enabled, the Automatic Liquid/Gel Detergent indicator on the panel will light up if there is liquid/gel detergent in the detergent box. If there is little or no detergent in the detergent box, the indicator will flash.



When the Automatic Liquid/Gel Detergent indicator starts to flash, there is enough detergent for at least 5 washing cycles.

- Factory settings of the Automatic Liquid/Gel Detergent Dosing System are based on the detergent amount recommended by detergent manufacturers.
- You can proceed to the Settings menu to change the Automatic Liquid/Gel Detergent Dosing setting according to your habits, or according to the recommendations by the detergent manufacturer if you are using a different liquid/gel detergent.



Please follow the instructions given in section “Operating the Product” to change the settings of the Automatic Liquid/Gel Detergent Dosing System and Rinse Aid.



In addition to liquid/gel detergents that function only as a detergent, there are also liquid/gel detergents that act as rinse aid and/or soften water. Follow the manufacturer’s recommendations when using these detergents.

Detergent manufacturer’s recommendations about the amount of liquid/gel detergent to be used are as follows:

For lightly soiled dishes	20 ml
For moderately soiled dishes	25 ml
For heavily soiled dishes	30 ml



Some gel-type detergents may not be suitable for automatic dosing as they are highly viscous. Apply this type of detergents onto the inner surface of the dishwasher’s door or directly into the dishwasher, paying attention to the recommendations of the detergent manufacturer.

Adding Liquid/Gel Detergent and Rinse Aid

The Automatic Liquid/Gel Detergent Dosing system is found on the door of your dishwasher.



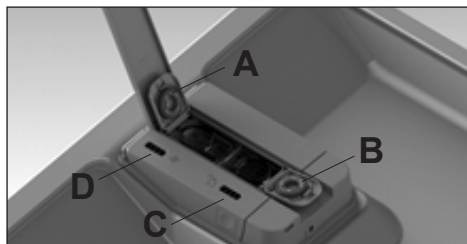

After fully opening the door of the dishwasher, open the decorative cover as shown with arrows 1 and



2. Open the cover shown with (A) in the picture and add rinse aid. Open the cover shown with (B), add liquid/gel detergent and close the covers.

 The indicator marked with (C) on your machine informs you about the liquid/gel detergent level in the box.

 The indicator marked with (D) on your machine informs you about the rinse aid level in the box.

 Wipe clean any spilled rinse aid outside the reservoir. Otherwise, it will cause foaming in the next washing cycle, reducing the washing performance of the product.

 The rinse aid used in dishwashers is a special product that is recommended to increase drying efficiency and prevent water or lime stains on the washed items. For this reason, care must be paid to have rinse aid in the rinse aid reservoir and to use rinse aids produced specially for dishwashers only.

Using the Automatic Liquid/Gel Detergent Dosing System

In order to use the Automatic Liquid/Gel Detergent Dosing function, select Automatic Liquid/Gel Detergent Dosing function on the control panel.

When the function is active, its indicator comes lit and the system uses appropriate amount of detergent and rinse aid in each washing program.

 Press the key again to cancel the function.

 When automatic liquid/gel detergent dosing function is selected, do not use other types (powder, tablet, etc) of detergents.

If you want to use another type of detergent while the automatic liquid/gel detergent dosing system is full, cancel the automatic liquid/gel detergent dosing function on the control panel. Then you can use powder, tablet or liquid/gel detergent.

 Use only liquid/gel detergent suitable for the dishwasher.

 Do not mix different brands of liquid/gel detergents.

 Do not fill the liquid/gel detergent box with liquids or chemical cleaners (vinegar, bleach etc.) other than liquid/gel detergent.

 Liquid/gel detergents that lost their fluidity and became firm must not be used in automatic liquid/gel detergent dosing system.

Liquid/gel detergents must be used in a short time once they have been unpacked. Unpacked liquid/gel detergents may lose their fluidity in time.



When the detergent warning lamp gives a warning, it will go away in a short while after you add liquid/gel detergent. If the warning light is still on after a washing cycle, you can remove the detergent cartridge, shake it a few times and reinstall it.

This may occur because of the blockage of the warning gauge due to the detergent residues remained in the cartridges after a long term use.

To avoid this, it is recommended to clean the detergent cartridge thoroughly once in two or three months.

You can soak it in lukewarm water, and you can wash with tap water.

This way, dosing problems caused by accumulated detergent residues, as well as blockage of the warning mechanism is prevented and it is ensured that the system works properly.



If a different brand or type of liquid/gel detergent will be used, make sure previous detergent is depleted completely and then remove and clean the liquid/gel detergent tank under tap water.



Fill the rinse air box only with rinse aid, and the detergent box only with liquid/gel detergent. If you fill it inappropriately, immediately remove the boxes, empty them and clean under running water.

Installing/Removing the Liquid/Gel Detergent and Rinse Aid Box

To remove the rinse aid and detergent boxes, push and lift the system cover on both sides as shown with arrows 1 and 2 and open.

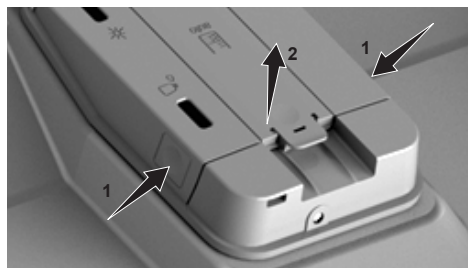

Lift and remove the rinse aid box (A).

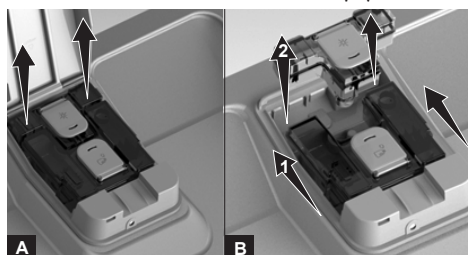

Move the detergent box (B) in the direction of the arrow (1) and lift to remove (2). Once the cleaning or filling procedure is complete, follow the above steps in reverse order to re-install the detergent and rinse aid boxes.

Powder Detergents



You can find the correct amount of powder detergent for the selected programme in the table "Programme Data and Consumption Values".



You can apply powder detergent onto the cover of the dishwasher or directly into the machine.



To use powder detergents, go to the Settings menu to disable the Automatic Liquid/Gel Detergent Dosing System and if any, the Tablet Detergent function.



Powder detergents must be used with programmes without Prewash. See Programme Data and Consumption Values.



Use powder detergent in short programmes without prewash since the solubility of the tablet detergent changes depending on the temperature and time.

3. Check quality and storing conditions of your detergent
4. Check water hardness on your region and make the necessary changes needed.
5. Clean your detergent cartridge periodically (every 3 month) to remove solid or viscous residues inside. These residues may cause insufficient dosage.
6. Increase the detergent dosage amount from the settings to improve the cleaning performance. "

TIPS ON LIQUID/GEL DETERGENT USAGE

After the program finished, if cups and saucers have stains inside or the color of them is changed, this may be due to the one of the following reasons, or even a combination of more ;

- Colored stains(eg: tea, coffee.) are left in the cup or saucer for a considerable time
- Using a short or low temperature wash cycle
- Stale or damp detergent
- Poor quality detergent
- Hard water area without the use of Rinse Aid
- Old or scratched crockery. (If you have any kind of surface damage to cups, you are far more likely to see stains.)

Washing algorithm of your dishwasher is optimized to provide better cleaning. If you face such kind of problems on your dishes please;

1. Do not leave your dishes with colored stains for a long time
2. Use longer programs like Eco or Intensive.

Tablet detergents

Table detergents exhibit water softening and / or rinse aid effect in addition to detergent effect. Some types of these detergents also contain special-purpose washing chemicals such as glass and stainless steel protectors.



Tablet detergents give satisfying results only under certain usage conditions. The best washing performance in dishwashers is obtained by using detergent, rinse aid and water softening salt individually.

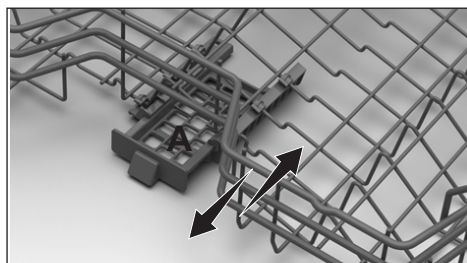

Place the tablet detergent into the Tablet Detergent Box found on the upper basket of the dishwasher (A).



When using tablet detergents, you can use the Tablet Detergent Function to improve the drying performance of the dishwasher (based on model).

Tablet detergent types commonly found on the market:

2in1: Contains detergent, rinse aid or water softening salt

3in1: Contains detergent, rinse aid and water softening salt

4in1: Contains glass protectors in addition to detergent, rinse aid and water softening salt

5in1: Contains glass and stainless steel protectors in addition to detergent, rinse aid and water softening salt



When using tablet detergents, follow the manufacturer's instructions on the packaging.



Contact the detergent manufacturer if your dishes are wet and/or if you notice limescale spots particularly on your glasses after the washing programme is over when using a tablet detergent.

When you switch to powder detergent from tablet detergent:

1. Make sure that salt and rinse aid reservoirs are full.
2. Set the water hardness to the highest level and perform an empty run.
3. After the empty washing cycle, review the user manual and readjust the water hardness level so as to suit the water supply.
4. Make the appropriate rinse aid settings.

Items not suitable for washing in the dishwasher

- Never wash dishes soiled by cigarette ash, candle remnants, polish, dyestuff, chemicals, etc. in your dishwasher.
- Do not wash silverware and cutlery with wooden or bone stems, glued pieces, or pieces that are not resistant to heat, as well as copper and tin-plated containers in the dishwasher.



Decorative prints of chinaware as well as aluminum and silver items may get discoloured or tarnished after washing in the dishwasher just as it happens in handwashing as well. Some delicate glass types and crystals may become dull in time. We strongly recommend you to check if the tableware you are going to purchase is suitable for washing especially in the dishwasher.

Placing the dishes into the dishwasher

You can use your dishwasher in the optimum way with respect to energy consumption and washing and drying performance only if you place the dishes in an orderly way.

- Wipe away any coarse food remnants (bones, seeds, etc.) on the dishes before placing them in the dishwasher.
- Place thin, narrow pieces in the middle sections of baskets if possible.
- Place the heavily soiled and bigger items in the lower basket and smaller, delicate and light items in the upper basket.
- Place the hollowed dishes such as bowls, glasses and pans upside down in the dishwasher. Thus, accumulation of water in deep hollows is prevented.



To prevent possible injuries, always place the sharp and pointed dishes such as service fork, bread knife, etc. upside down so as their pointed ends will face down or they will lie horizontally in the dish basket.

Unload dishes in the lower basket first and then the dishes in the upper basket.

Suggestions for loading the dishwasher

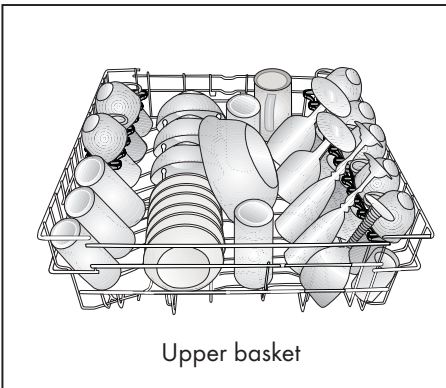
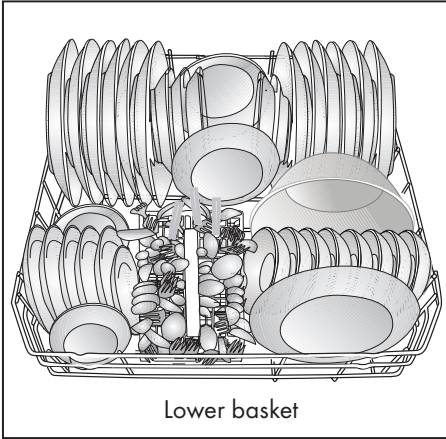

Improper Loading Of Dishware

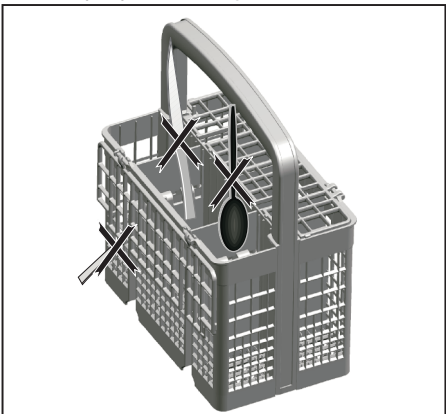

Improper Loading Of Dishware

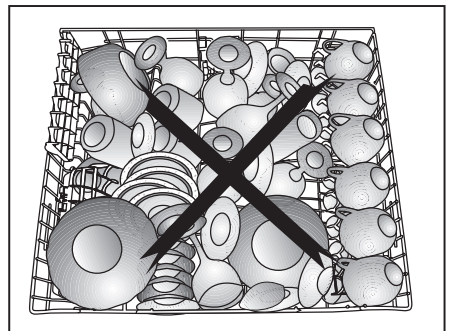
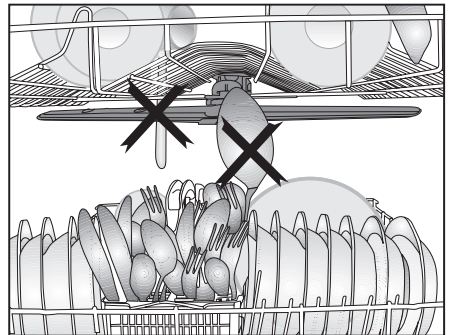
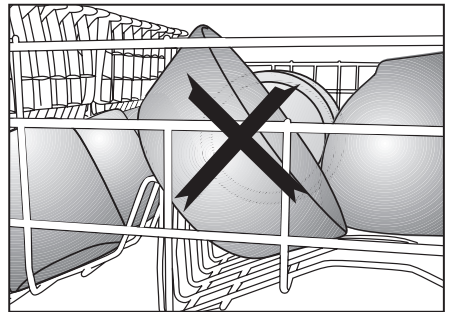
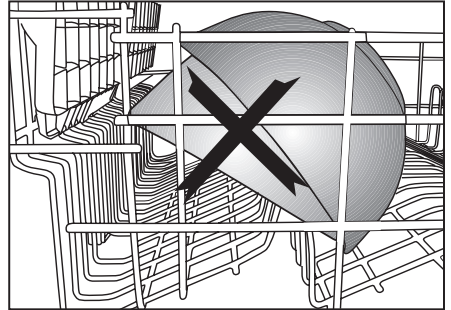

Cutlery basket

(depends on model)

Cutlery basket is designed to wash your dishes such as knife, fork, spoon, etc. in an efficient manner.

Since the cutlery basket can be moved (A, B), you can create more space while placing your dishes in the lower basket and free up space for your dishes of different sizes.

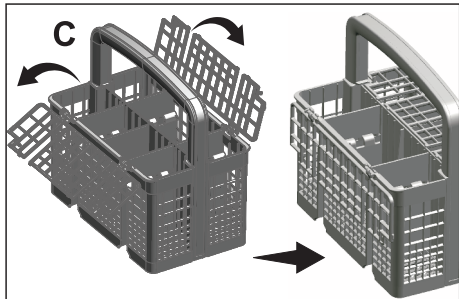
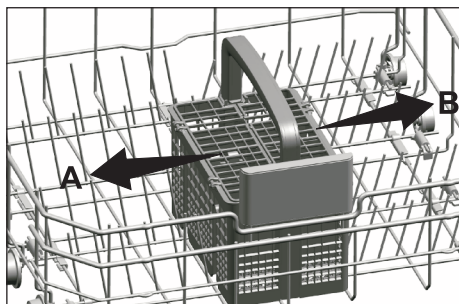

Cutlery basket

(depends on model)

Cutlery basket is designed to wash your dishes such as knife, fork, spoon, etc. in an efficient manner.

Since the cutlery basket can be moved (A, B), you can create more space while placing your dishes in the lower basket and free up space for your dishes of different sizes..

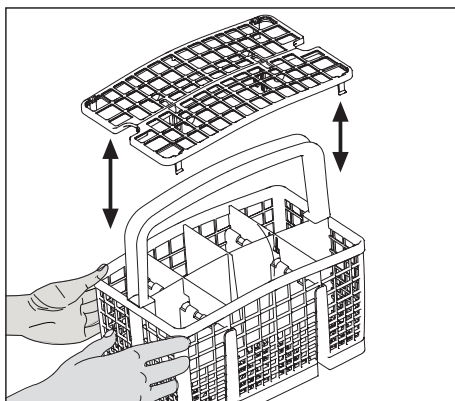
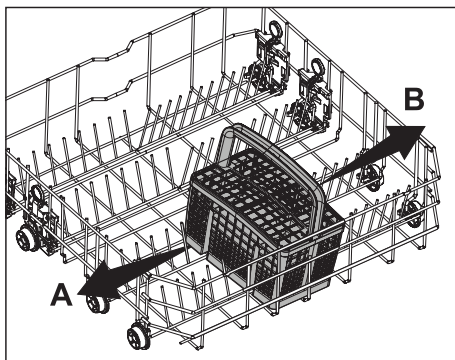

Collapsible lower basket tines

(depends on model)

There are foldable tines (A) located at the lower basket of the machine are designed for an easier placement of large pieces such as pans, bowls, etc. You can create larger spaces by folding each tines individually or all of them at once.

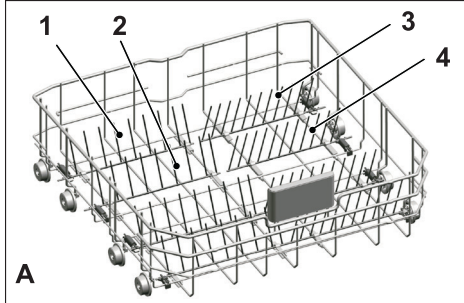

To bring the collapsible tines into horizontal position, grab the tines from mid position and push them in the directions of arrows (B). To bring the tines back to vertical position, just lift them up. Collapsible tines will click into the latch again (C).

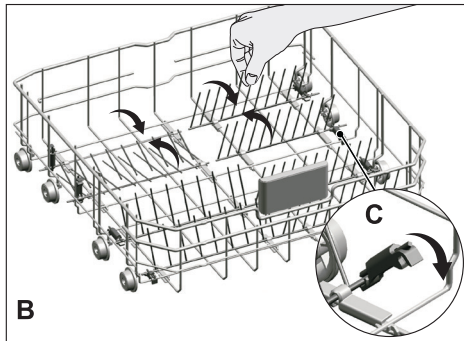

Bringing the tines to the horizontal position by holding them from the tips may cause them to bend. Therefore, it will be appropriate to bring the tines in the middle to horizontal or vertical position by holding them from their stems and pushing in the direction of arrow.

Collapsible lower basket tines

(depends on model)

There are foldable tines (A) located at the lower basket of the machine are designed for an easier placement of large pieces such as pans, bowls, etc. You can create larger spaces by folding each tines individually or all of them at once.

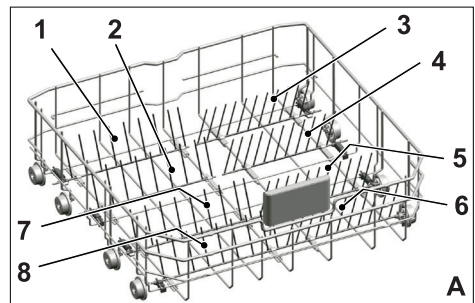

To bring the collapsible tines into horizontal position, grab the tines from mid position and push them in the directions of arrows (B). To bring the tines back to vertical position, just lift them up. Collapsible tines will click into the latch again (C).

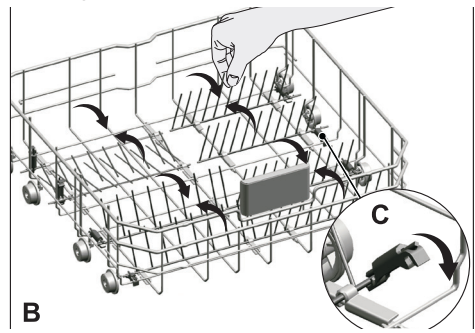

Bringing the tines to the horizontal position by holding them from the tips may cause them to bend. Therefore, it will be appropriate to bring the tines in the middle to horizontal or vertical position by holding them from their stems and pushing in the direction of arrow.

Tray Wash Supports

(depends on model)

Use the supports to wash trays in the bottom basket.

See the Auxiliary functions section for appropriate programme and function selection.

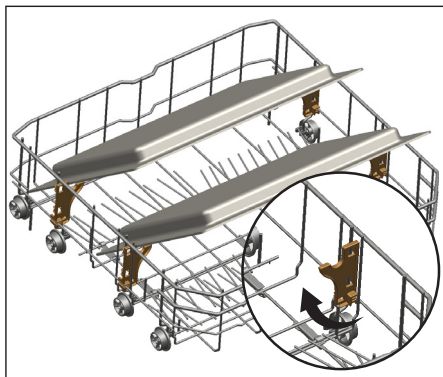

SoftTouch Accessory

(depends on model)

The SoftTouch Accessory found in the lower basket of your machine enables a safe washing for your fragile glasses.

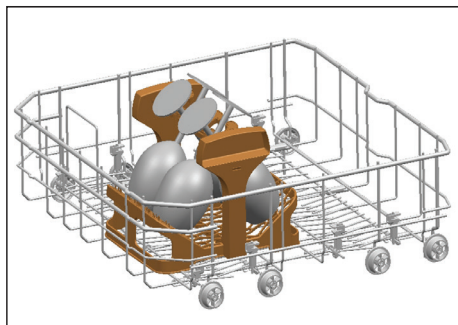

Lower Basket Glass Holder

(depends on model)

Lower Basket Glass Holder found in the lower basket of your machine enables a safe washing for your oversized and tall glasses.

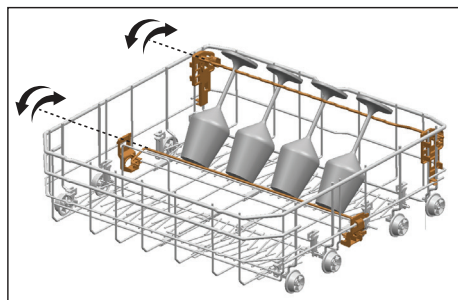

Lower basket multipurpose / height adjustable service rack

(depends on model)

This accessory located at the lower basket of your machine allows you to easily wash pieces such as extra glasses, long ladles and bread knives.

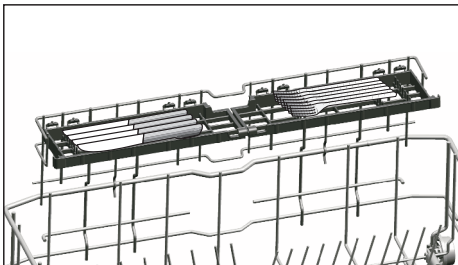
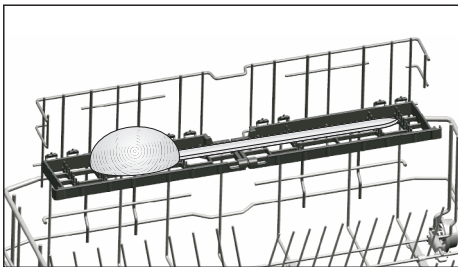
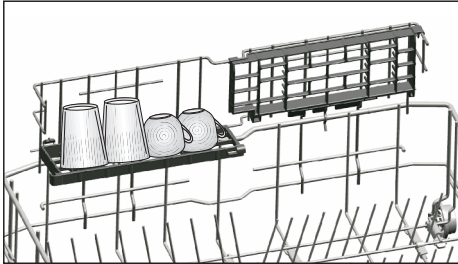

You may use the racks as required by moving them to lower or upper position, or close them to create a wider space in your lower basket.



Make sure that the impeller does not touch the dishes you placed on the racks.

To close the racks:

1. Fold the rack (A).
2. Slide the rack up (B).
3. Put the rack in vertical position (C).
4. Slide the rack down and lock it by the tabs (D).

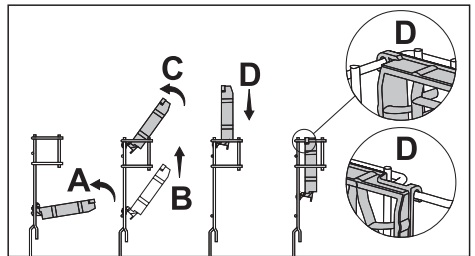

You may open the racks in the same process in reverse order.

To adjust the height of the racks:

1. Fold the rack (E).
2. Slide the rack up (F).
3. Open the rack at the desired level (G).

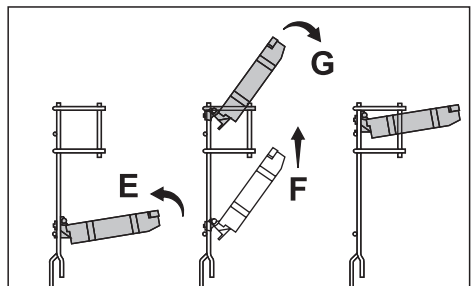

Lower basket bottle wire

(depends on model)

The bottle wire is designed for easier washing of long pieces with wide mouths. You may take out the bottle wire from the basket when not in use by pulling it out from both sides (H).

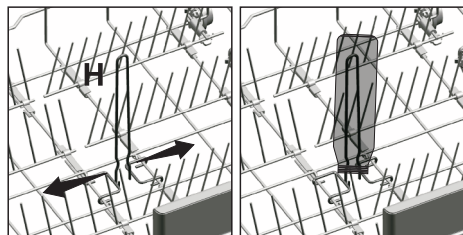

Upper basket height adjustable rack

(depends on model)

Use the lower and upper parts of the height adjustable racks in the upper basket of the machine by sliding them down or up according to the heights of the glasses, cups or etc. (A, B, C).

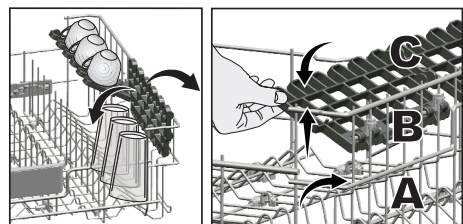

Upper basket multipurpose service rack

(depends on model)

This accessory located at the upper basket of your machine allows you to easily wash pieces such as extra long ladles and bread knives.

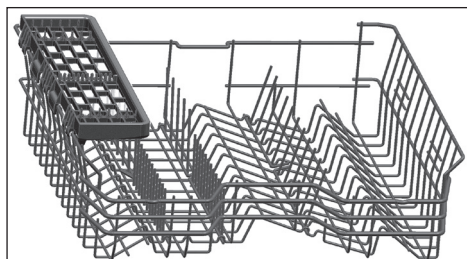

You can lift up the upper basket multipurpose service rack to remove it if you do not want to use it.



If you want to use the upper basket multipurpose service rack again, you can easily attach it to the side section of your upper basket.



Adjusting the height of the upper basket

(depends on model)

The upper basket height adjustment mechanism has been designed for you to create large spaces in the lower or upper sections of your machine depending on your needs by adjusting the height in the upper or lower direction while your basket is empty or loaded.

Thanks to this mechanism, you can use your basket in three different positions, namely lower, middle and upper positions (1, 2, 3).

1. To raise your basket, hold the upper basket wires with both hands while the basket is in the lowermost position and pull them up (A).
2. You will hear a "Click" from the right and left mechanisms, indicating that the basket has reached the next level. Release the basket.

Repeat the process if the height is not sufficient.

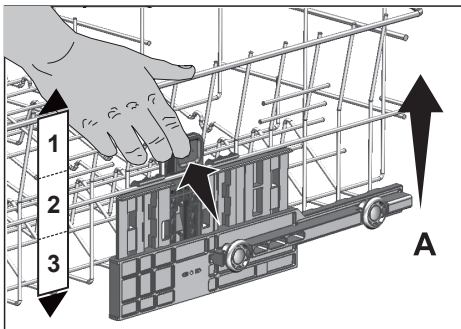

To lower the basket, while it is in the uppermost position;

1. Hold the upper basket wires with both hands, slightly lift up the basket and simultaneously push and release the latches shown in the figure (B).
2. Lower the basket from its current position to the lower one.
3. Release the basket after it has reached one level down.

Repeat the process if the height is not sufficient.

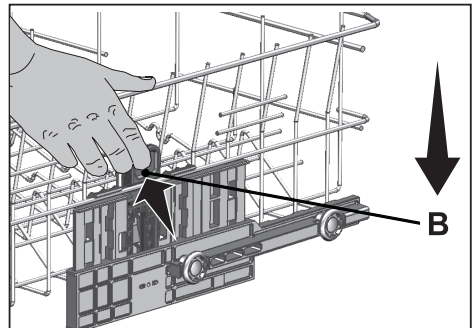

The movement mechanism may not function properly if the upper basket is overloaded or if the weight distribution is not balanced. In heavier conditions, there is the risk of falling one level down.



Make sure that the adjustment mechanism has the same positions on the right and left sides of the upper basket.

Collapsible upper basket wires

(depends on model)

You can use collapsible wires when you need a larger space for your dishes in the upper basket of your machine.

To bring the collapsible wires into horizontal position, grab the wire from the middle position and push them in the direction of arrow in the figure. Place your larger dishes into the area created. To bring the wires back to vertical position, just lift them up.

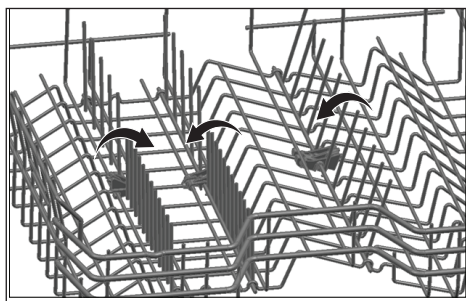

Bringing the wires to the horizontal position by holding them from the tips may cause them to bend. Therefore, hold the wires from their stems while bringing them to the horizontal or vertical positions.

Height setting with empty basket

(depends on model)

In this model, the height setting of the upper basket may be changed using the wheels which are mounted at two different heights. Release the latches on both the right and left tracks of the upper basket by pushing them outwards.

Pull the basket out completely.

Place the basket back into the tracks at the desired height.

Push the latches back into the correct position.

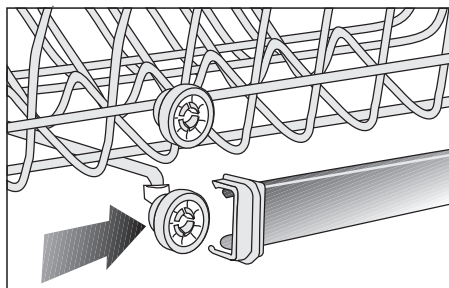
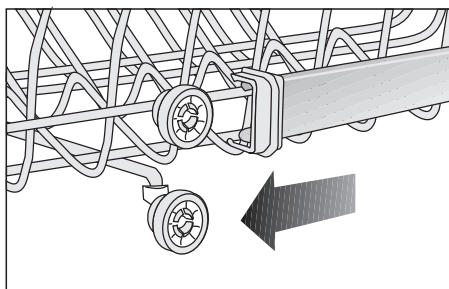
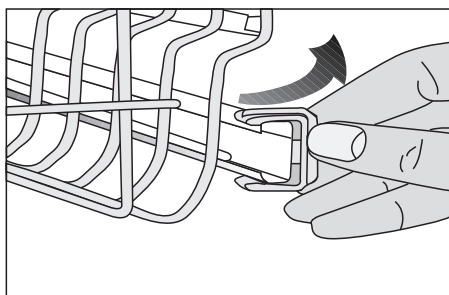

Ceiling cutlery basket

(depends on model)

Ceiling cutlery basket is designed to wash your cutlery items such as forks, spoons and etc. by placing them between the bars on the basket.

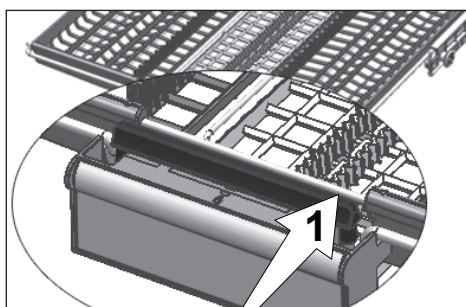
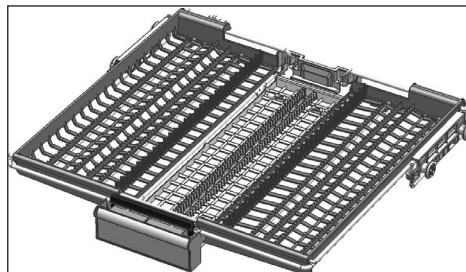

In models with partial movement feature, pushing the bar (1) on the handle enables the central tray of the basket to get to the lower position and the system gets unlocked. Thus right and left side trays can be used as moving parts.

The free space enabled by the side trays allows long parts to be loaded in the upper basket.

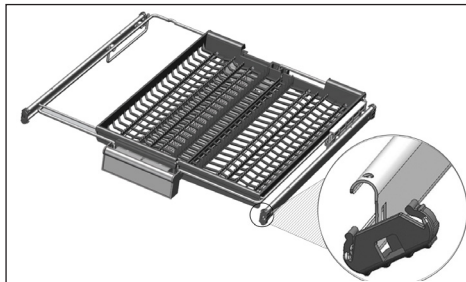
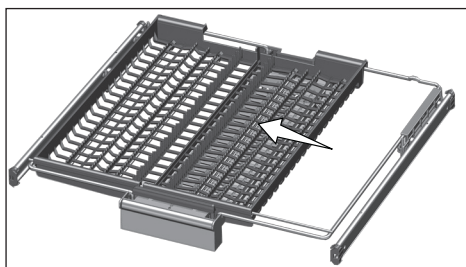

When the central tray is in the lower position, you can load long/high items such as coffee cups, ladles, etc. on the tray. When the side trays lean on two side walls, the handle can be pulled to allow the central tray to rise and the system to be locked.

Ceiling cutlery basket

(depends on model)

Ceiling cutlery basket is designed to wash your cutlery items such as forks, spoons and etc. by placing them between the bars on the basket.

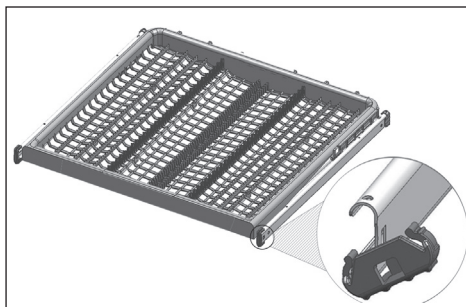

5 OPERATING THE PRODUCT

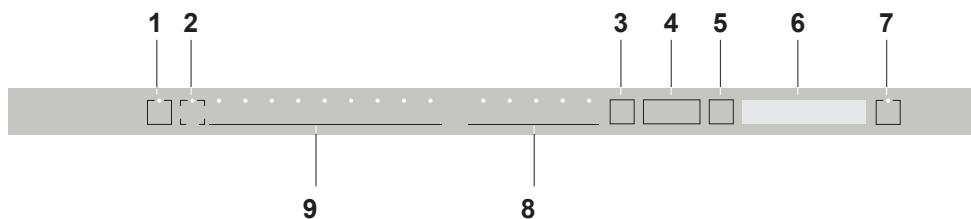

- | | |
|---|-----------------------------|
| 1. On / Off Key | 8. Function Selection Keys |
| 2. RemoteStart Key | F1 TurboWash Function |
| 3. Menu Key | F2 Express Function |
| 4. Time Delay Selection / Menu Direction Selection Keys | F3 Steam Shine Function |
| 5. Selection / Confirmation Key | F4 Perfect Rinse Function |
| 6. Display | F5 Half Load function |
| 7. Start / Pause / Cancel Key | 9. Programme Selection Keys |

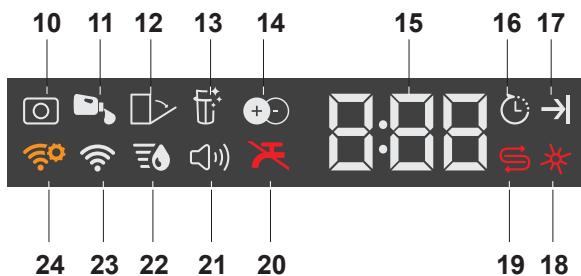

- | | |
|---|--|
| 10. Tablet Detergent Indicator (depends on the model) | 15. Delay Time / Programme Time Indicator |
| 11. Liquid Detergent Dosing Indicator (depends on the model) | 16. Delayed Start Indicator |
| 12. Auto Door Open Indicator (depends on the model) | 17. End of Programme Indicator |
| 13. Filter Cleaning Function Indicator (depends on the model) | 18. Rinse Aid Indicator |
| 14. IonFresh Function Indicator (depends on the model) | 19. Salt Indicator |
| 20. Water Cut-off Indicator | 21. Sound Settings Menu Indicator |
| 21. Sound Settings Menu Indicator | 22. Water Hardness Settings Menu Indicator |
| 22. Water Hardness Settings Menu Indicator | 23. HomeWhiz Indicator |
| 23. HomeWhiz Indicator | 24. HomeWhiz Setting Indicator |
| 24. HomeWhiz Setting Indicator | |

On/Off Key

When you press the On/Off key, the indicator lights illuminate on the display for ON position. The lights turn off in OFF position.

Programme Selection / Programme Cancel key

Select the desired programme using the "programme selection keys" and press the button.

To cancel the running programme, open the door of the machine and press and hold the Programme Start/Pause/Cancel key for 3 seconds.

After the 3 - 2 - 1 countdown, 0:01 is displayed, close the door of the product and wait for the draining process complete. Draining is completed in 2 minutes and the machine gives an audible warning when it is completed.

Function Keys

If you press any of the Function keys during programme selection or time delay selection, an affirmative key signal will be heard provided that the relevant function is supported by the selected programme. Function will be deemed selected when the indicator of the selected function is lit. To cancel the selected function, keep the function key pressed until the function indicator disappears.

Preparing the machine

1. Open the door of the dishwasher.
2. Place the dishes in accordance with the instructions in the user manual.
3. Make sure that the upper and lower impellers rotate freely.
4. Put adequate amount of detergent into the detergent dispenser.

Programme selection

1. Press the On/Off button to turn on your machine.
2. Check the Salt and Rinse Aid indicators and add salt and/or rinse aid if needed.
3. Refer to the table of "Programme data and average consumption values" to determine a washing programme suitable for your dishes.
4. Selected programme will start when you close the door of your machine.

Programme Table

Programme number	1	2	3	4	5	6	7	8	9
Programme name	Auto	All-in-Wash	Intensive	Eco *	GlassCare	QuickWash	Mini	Prewash	Downloaded Programme
Cleaning temperature	40 °C-65 °C It determines the soiling degree of the dishes and sets the temperature and amount of the washing water as well as the washing time automatically. It is suitable for all dish types.	- It is the most suitable programme for daily mixed dishes including plastic items. While delicate glass items are washed in the upper basket, pans and trays can be washed in the lower basket.	70 °C It is suitable for heavily soiled pans and trays.	50 °C It is suitable for washing the normally soiled left daily dishes in the most economical way.	40 °C Special programme for gentle cleaning of delicate glassware.	60 °C It is the daily washing programme to wash the normally soiled left dishes in the fastest way.	35 °C It is suitable for quickly washing the lightly soiled dishes that have undergone pre-cleaning process.	- It is suitable to remove the rough remnants on the dishes to be left in the dishwasher. It also prevents odour formation inside the machine.	- Please see the table on the other page for programmes you can download through wireless connection.
Degree of Soiling	Medium to high	Medium	High	Medium	Low	Medium	Low	-	-
Prewash	+	+	+	+	+	-	-	+	-
Wash	+	+	+	+	+	+	+	-	-
Dry	+	+	+	+	+	+	-	-	-
Duration (min)	110-173	202	170	279	120	58	30	15	-
Water (l)	9,4-12,4	19	16,8	9,9	13,6	10,6	10,8	4	-
Energy (kWh)	0,90-1,45	1,53	1,51	0,84	1,20	1,18	0,80	-	-

The consumption values shown in the table were determined under standard conditions. Differences may therefore occur under practical conditions. * Reference programme for testing institutes. The tests in accordance with EN 50242 must be carried out with a full water softener salt dispenser and a full rinse aid reservoir and using the test programme

Download Cycle				
Programme number	1	2	3	4
Programme name	HygieneCare	DailyWash	SilentWash	SelfCare
Cleaning temperature	70 °C	65 °C	50 °C	-
Degree of Soiling	Using this would be appropriate to wash heavily soiled dishes left for a long time and when extra hygiene is needed especially to wash baby stuff.	Daily washing programme for normally soiled dishes.	It is the daily washing programme to wash the normally soiled left dishes in the most silent way.	This programme is recommended to be operated on every 1-2 months for machine cleaning and necessary hygiene. The programme should be operated while the machine is empty. In order to achieve an efficient result use together with special machine.
Prewash	High	Medium	Medium	-
Wash	+	-	+	-
Dry	+	+	+	-

Auxiliary functions

Washing programmes of your dishwasher are designed to obtain the best cleaning effect, considering the type of the soiling, soiling degree and properties of the dishes to be washed.

Auxiliary functions allow you save from time, water and power.



Auxiliary functions may cause changes in the programme duration.



Auxiliary functions are not suitable for all washing programs. Indicator of the auxiliary function that is not compatible with the programme will not be active.

TurboWash Function

This function operates the lower impeller with a higher pressure and higher speed to enable a better washing for dishes such as pans and trays with stubborn, dried soiling.

Express Function

It shortens the time of the washing cycle selected and decreases water consumption by enabling washing under higher pressure.

Steam Shine Function

It provides superior drying performance.

Perfect Rinse Function

Depending on the type of the detergent used, if a detergent dissolving issue is encountered it will remove the resulting stains from the dishes and enables the optimum rinsing performance.

Half Load function

It is used to operate the machine without loading it completely.

1. Load your dishes in the machine as you like.
2. Turn the machine on with On/Off key.
3. Select the desired programme and press the Half Load key.

While the function is active, the selection indicator on the selected function key will become on.

4. Close the door of the machine to start the programme.



With the Half Load function you can save both water and power while using the lower and upper baskets of the machine.

Floor illumination

Warning to show that machine is in washing phase

(depends on the model)

Your machine reflects a light to the floor during the washing process. This light turns off after the washing process is complete.



Floor illumination is activated automatically when the washing programme starts and remains lit until the end of the programme.



Floor illumination cannot be cancelled by the user.

Functions Under the Settings Menu

(depends on the model)

Under the settings menu of your product, there are some additional functions that depend on the model.

To access these functions, press and hold the Menu key for 3 seconds. Use <- and +> to proceed to the desired function or setting.

Use the selection key to change the desired function or setting and press the Menu key to exit the Settings menu.



The function indicator will light up even if the functions activated on the settings menu are not active in the selected washing programme.

Submenu Functions:

(depends on the model)

Doormatic Function Off/On



Detergent Tablet Function Off/On



Active Self Cleaning Function Off/On



IonFresh Function Off/On



Liquid Dosing Function Off / On



Liquid Dosing Function detergent use setting:

- Level 1: 10 cc lower than the default value
- Level 2: 5 cc lower than the default value
- Level 3: Use the default detergent amount determined by the programme.
- Level 4: 5 cc higher than the default value
- Level 5: 10 cc higher than the default value

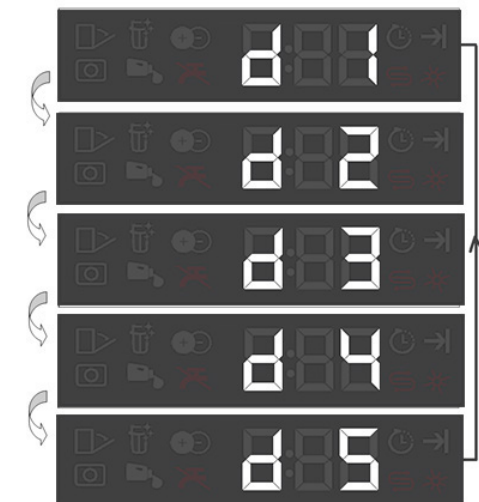

Changing Warning Sound Volume

1. After switching on your machine, press the Menu key for 1 second.
2. Press < and > to proceed to "S:" on the display.
3. Each pressing on the Selection key will change the warning sound volume as "S:0" off, "S:1" medium and "S:2" high.
4. Press the Menu key to exit the settings menu. Your setting will be saved automatically.



Your machine is set to "S:2" as factory default.

Interior Lighting

(Depends on the model)

Some models have interior lighting to illuminate the interior when the door is opened.

Changing the interior lighting setting

1. After switching on your machine, press the Menu key for 1 second.
2. Press < and > to proceed to "L:" on the display. Select the position you want with the Selection key. Interior lighting is off in "L:0" position and on in "L:1" position.
3. Press the Menu key to exit the settings menu. Your setting will be saved automatically.

Automatic Detergent Dosing Function

The Automatic Detergent Dosing function automatically adjusts the liquid/gel detergent use according to the selected washing programme and your settings.



To activate or deactivate the function, proceed to "Functions" under the "Settings" menu and follow the instructions regarding the automatic liquid/gel detergent dosing function.

Tablet detergent function

Allows to obtain a better drying performance from the multi-purpose detergents called as all in one detergents such as 2in1, 3in1, 4in1, 5in1 and etc., depending on the hardness level of the tap water.



If you have used the Tablet features during the last washing programme you used, Tablet function will remain active in the next washing programme you will select.



Tablet Detergent function may cause change in the programme duration.

IonFresh function

"IonFresh function" is enabled at regular intervals and prevents the formation of bad odours due to putrefaction. If this function is selected, it will be activated while the product is turned off and the IonFresh indicator on the panel will flash. A ventilation noise can be heard, this is normal. Until the function selection is disabled, system is automatically activated intermittently.

Scheduling the washing time

Time Delay

If an economical electricity tariff is applied in your region, you can use the Time Delay function to wash your dishes during appropriate hours.

You can delay the start of the selected programme until 24 hours.

1. Press the Time Delay function key after selecting the washing programme and other auxiliary functions.
2. Once you press the Time Delay key, Display Information Line will show "0:30" and Time Delay indicator will start flashing.

3. Set the desired time by pressing the Time Delay key. Time will increase with increments of 30 minutes up to 6 hours and after that in 1 hour increments up to 24 hours every time you press the key.
4. Close the door of your machine after setting the Delayed Start. Once the delay time is over, the selected programme will start automatically.

Changing the settings while Time Delay function is active

While the Time Delay function is activated, you cannot make changes in the washing programme, auxiliary functions or the duration of delay time.



Programme and auxiliary functions cannot be set/changed after the programme has started.

To cancel the Time Delay function

Open the door of the product Press and hold the Programme Selection / Programme Cancel keys for 3 seconds. After the 3 - 2 - 1 countdown, 0:01 is displayed, close the door of the product and wait for the draining process complete. Draining is completed in 2 minutes and the machine gives an audible warning when it is completed.



You can select and start a new programme following the cancellation of Time Delay function.



Time Delay function cannot be set after the programme starts.

Starting the programme

Close the door of your machine to start it after selecting the programme and auxiliary functions.



Your machine performs water softening depending on the hardness level of the supply water. Washing time can change while the programme is running depending on the ambient temperature where your machine is installed, temperature of the supply water and amount of the dishes.



Pay attention not to open the door of the machine when it is running. There may be a rush of vapour when you open the door of your machine; be careful.



The machine will remain silent in pause mode for some time in order to remove the water from the machine and on the dishes completely and to have the water softener cleaned, and then it will resume running in drying mode.

Cancelling the programme

Open the door of the product Press and hold the Programme Selection / Programme Cancel keys for 3 seconds. After the 3 - 2 - 1 countdown, 0:01 is displayed, close the door of the product and wait for the draining process complete. Draining is completed in 2 minutes and the machine gives an audible warning when it is completed.



There might be residues of detergent or rinse aid in the machine and/or on the pieces being washed depending on the step the programme you have cancelled was in.

Salt indicator (Ⓢ)

Please check the salt indicator on the display to see whether there is adequate amount of softening salt in the dishwasher or not. You need to refill the salt reservoir with salt whenever salt indicator appears on the display of your machine.



Adjusting the water hardness level is explained in Water Softening System section.

Rinse Aid indicator (☼)

Please check the rinse aid indicator on the display to see whether there is adequate amount of rinse aid in the dishwasher or not. You need to refill the rinse aid reservoir with rinse aid whenever rinse aid indicator appears on the display of your machine.

Adjusting the amount of rinse aid

1. After switching on your machine, press the Menu key for 1 second.
2. Using <- and +> keys, proceed to "P:" on the display.
3. Set to the appropriate level with the Selection key.
4. Press the Menu key to exit the settings menu. Your setting will be saved automatically.

No rinse aid dispensed in P:0 wash position.

1 dose of rinse aid is dispensed in P:1 position.

2 doses of rinse aid are dispensed in P:2 position.

3 doses of rinse aid are dispensed in P:3 position.

4 doses of rinse aid are dispensed in P:4 position.

End of programme



When the programme you have selected comes to an end, an audible warning signal will warn you to turn off your machine. This audible signal will warn you with certain intervals before it turns off.

End of Programme indicator will light up when the washing programme is over.

1. Open the door of the machine.
2. Press On/Off key to turn off your machine.
3. Close the tap.
4. Unplug the machine from the socket.



For energy saving, the machine is automatically turned off following the completion of the programme or if the programme is not started.



Leave your dishes in the machine for about 15 minutes to allow them cool down after they are washed. Your dishes will dry in a shorter time if you leave the door of your machine ajar during this period. This process will increase the drying effectiveness of your machine.

Water cut-off warning

If mains water is cut or water inlet tap is turned off the machine cannot take water in and E:02 icon will flash on the programme indicator. As long as the problem continues, washing programme is paused and the water inlet is checked regularly by the machine; when the water is restored E:02 icon will disappear after a while and the washing programme resumes.

Overflowing warning

If the machine intakes too much water or there is leakage at any of the components then the machine will detect this and E:01 icon will flash on the Programme indicator. As long as the overflowing continues safety algorithm will be active and try to discharge the water. If overflowing stops and safety is assured, E:01 icon will disappear. If E:01 does not disappear, there is a permanent fault. In this case the authorised service should be contacted.

6 HOMEWHIZ FUNCTION

You can check your dishwasher and learn about its status via your smart device with the HomeWhiz function.



HomeWhiz only runs on a frequency band of 2.4GHz.



You can use your machine via your smart device while the function is selected. You can monitor your machine through the application when the function is not selected.



You can check the indicator on the product to see if the function is enabled or not.

If the function is disabled, the Wireless indicator will be off or continuously flash at short intervals. For example, when the wireless connection setting is off or the door of the machine is open.



The function will be disabled when the door of the dishwasher is open or when operations regarding On/Off are performed on the machine. It can be enabled again with the remote control key.

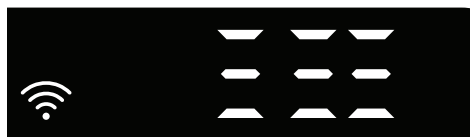

The display when HomeWhiz is enabled.

HomeWhiz Setup and User Account Settings

Install the HomeWhiz application from the application store of your smart device to use the WLAN function of your machine. Make sure that your smart device is connected to the internet to use the application.

If you are using the application for the first time, complete the registration process with your e-mail address on the application. Once you've completed the registration process, you can use all HomeWhiz supported appliances in your house through this account.

You can tap "Add/Remove Appliance" under the "Appliances" section to see the appliances paired with your account. You can perform the user pairing processes of these appliances from this page.

Initial setup

- 1 Tap "Add/Remove Appliance" section on the HomeWhiz application.
- 2 Tap "Tap here to setup a new appliance".
3. When the product is off, press the on/off and remote start keys simultaneously to enter the settings menu. Press the selection key to set the product to "wireless connection setup" status.
4. Then, in the settings section of your smart device, connect to "HomeWhiz xxx-xxxx" network under the Wireless settings. Password of the network can be seen on the HomeWhiz application.
5. Connect your smart device to the HomeWhiz network and return to the HomeWhiz application. On the application, you can see the dishwasher you are adding. Tap Next to proceed to the next step.

6. Select the network to which you want to connect your dishwasher and enter the password.
7. While the dishwasher is connecting to the selected network, you will see the Wireless icon (📶) flashing. Once the connection has been established, the said icon will become on permanently.
8. Once your dishwasher is connected to the selected network, you need to connect to the same network on your smart device. If your smart device does not get connected automatically, go to its settings and connect it to the network to which your dishwasher is connected.
9. Return to the HomeWhiz application and give a name to your dishwasher. This is the last step. You can see your product on the "Products" page.
10. Once the setup of the dishwasher has been performed successfully, the product will show the main screen automatically and return to the use mode.
11. If the setup has failed, or if it could not be completed within 5 minutes in the setup mode, the Wireless icon will go off and the product will switch to the off mode. To perform setup again, please repeat the steps starting from step 1.

Using the dishwasher on more than one device

You can use your dishwasher on more than one smart device. Install the HomeWhiz application on the other smart device to use this feature. You need to log in with your account upon launching the application.

	If the account you have logged on is the one to which you have added appliance(s) before, you can start using your dishwasher directly after logging in.
--	--

Follow the steps below to use an already setup dishwasher through a new account.

1. Create a new account and use this account to log into the HomeWhiz application. Make sure that your smart device and dishwasher are connected to the same network.
2. Tap "Add/Remove Appliance" on the Products page. You can see the appliance and the user it belongs to under "Other Appliances" tab.
3. Tap (+) next to the dishwasher you want to add and give a name to the appliance.
4. Your request to add the appliance will be sent to its owner via e-mail. You can start to use the appliance jointly once the owner confirms your request.

	Your smart device and dishwasher do not need to be connected to the same network once the setup processes are complete. You can use your appliance as long as your smart device is connected to the internet.
---	---

	You can tap "Add/Remove Appliance" under the "Appliances" section to see the appliances paired with your account. You can perform the user pairing processes of these appliances from this page.
---	--

HomeWhiz on/off

Press the remotestart key to enable the function.

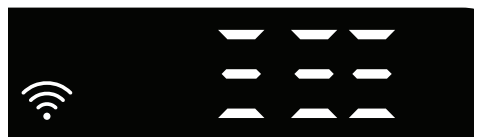

Product indicator when the function is enabled.

If you press the remote start key while the function is enabled, the Home Whiz function will be disabled, and the product indicator will return to the delay time/programme time display. In the off position, the HomeWhiz key LED will go off.



You can check the indicator on the product to see if wireless connection is enabled or not. If the wireless connection is off, you can see that the Wireless icon is off. If the Wireless icon is on, this means that the wireless connection of the product is on and the product is connected to the wireless network. If the Wireless icon is continuously flashing at regular intervals, this means that it is enabled but could not connect or is trying to connect to the network.

Wireless connection on/off

When the machine is on, press the "Menu" key for 1 second to enter the settings menu. Follow the screen and press <- and +> keys on the panel, then wait until the Wireless connection indicator comes on. Press the selection key and if the Wireless connection is on, turn it off; if it is off, turn it on. In the wireless connection on/off settings menu, if the wireless connection is on, the Wireless connection indicator will light permanently; if it is off, the Wireless connection indicator will flash at short intervals.

Once the wireless connection has been turned "On", your machine will connect to the home network by using the setup settings you made before.

Deleting the HomeWhiz settings

While the dishwasher is on, press and hold Remote start and Menu Direction Selection (-) keys on the panel for 5 seconds. After the 5 - 4 - 3 - 2 - 1 countdown on the display, your settings will be deleted.

HomeWhiz troubleshooting

Follow these instructions if you encounter a control or connection problem. If it persists, take the next step.

1. Check if your smart device is connected to the internet.
2. Close the HomeWhiz application on your smart device and start it again.
3. Restart your smart device.
4. Check the wireless connection status of your dishwasher. If you see "WLAN: Off", switch it to "WLAN: On" and wait for the machine to connect. Then close the HomeWhiz application on your smart device and start it again.
5. If the connection cannot be established following the instructions above, repeat the initial setup settings on the appliance.
6. If the problem persists, contact the authorised service.

Changing the Downloaded Program

You can use the HomeWhiz application to change the Downloaded Programme, which is the last program on the product. You can check the Table of Program Data and Average Consumption Values to see what the downloaded programs might be and the default Downloaded Program.

To change the Downloaded Program:

- Connect to your product on the HomeWhiz application.
- Turn on the Remote Control function for the product.
- Go to the settings page of the product on the HomeWhiz application.
- On the settings page of the product, proceed to the Download Program page.
- On the Download Program page, select a program to download on your product.
- Select the desired program on the Download Program page, and press Download Program on the HomeWhiz application.
- While the program is being downloaded, you will see an animation on the program and HomeWhiz application.
- Once the download procedure is complete, you can select and install the Downloaded Program on the product or the HomeWhiz application.



You can download as many programs as you wish on the product, and change the Downloaded Program whenever you want. You just need to make sure that your smart device and product are connected to the internet and the Remote Control function of the product is turned on.



You can check the Table of Program Data and Average Consumption values to see the programs you can download on your product.



If you download another program on the product, your previous selection will be cancelled.

7 MAINTENANCE AND CLEANING

Service life of the product extends and frequently faced problems decrease if it is cleaned at regular intervals.



Unplug the product and turn off the tap before attempting any cleaning procedures.



Do not use abrasive substances for cleaning.



Clean the filter and impellers at least once a week in order for the machine operates efficiently.

Cleaning the outer surface of the product

Wipe the outer surface and door gaskets of the product gently with a mild cleaning material and damp cloth. Wipe the "Control panel" only with a slightly damp cloth.

Cleaning the interior of the machine

- Clean the interior of the machine and the tank by running a programme with or without detergent based on the degree of soil.
- If water has remained in the machine, drain the water by performing the procedures under the topic "Canceling a programme". If the water cannot be discharged, remove the filters as specified in the "Cleaning the filters" section and check if there are any leftover deposits that have accumulated at the bottom of the machine, blocking the water path. Clean if necessary.

Cleaning the filters

Clean the filters at least once a week in order for the machine operates efficiently. Check if food residues are left on the filters. If there are food residues on filters, take them out and clean well under running water.

1. Turn the micro filter (1) and coarse filter (2) assembly counter clockwise and pull it out from its seating.

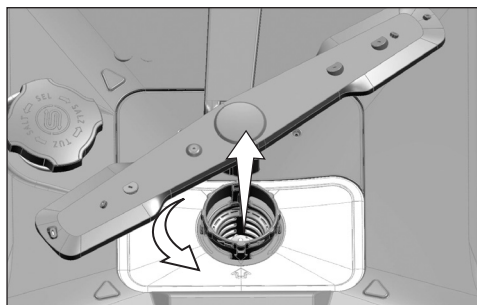

2. Pull out the metal/plastic filter (3) from the seating.

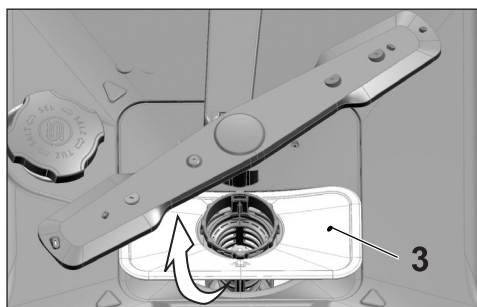

3. Press the two pawls on the coarse filter inwards and separate the coarse filter from the assembly.

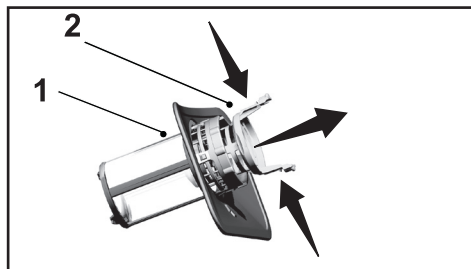

4. Clean all three filters under tap water by means of a brush.
5. Place the metal/plastic filter.
6. Place the coarse filter into the micro filter. Make sure that it is properly seated. Turn the coarse filter clockwise until a "click" sound is heard.



Do not use the dishwasher without filter.



Incorrect placement of the filters will reduce washing efficiency.

Cleaning the hose filter

Damages on the machine that may be caused by impurities coming from the urban supply water or your own water installation (such as sand, dirt, rust, etc.) can be prevented by means of the filter attached to the water inlet hose. Check the filter and the hose regularly and clean them if necessary.

1. Turn off the tap and remove the hose.
2. After taking out the filter, clean it under running tap water.
3. Place the cleaned filter back to its seat in the hose.
4. Install the hose to tap.

(depends on model)

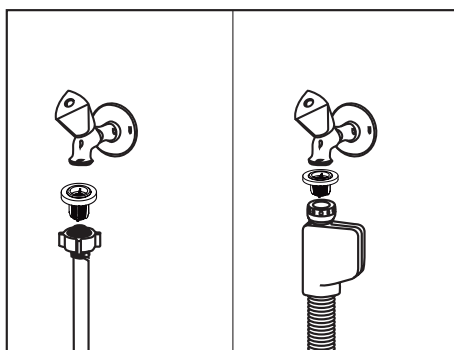

Cleaning the impellers

Clean the impellers for the machine to work efficiently.

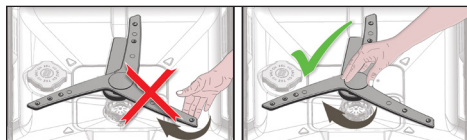

Do not try to rotate the impeller by holding its ends. Trying to rotate the end sections may cause the gear system within the impeller to break.

Lower impeller assembly



If the washing performance decreases, check if the holes on the lower impeller assembly are clogged. If they are clogged, remove and clean the impeller assembly.

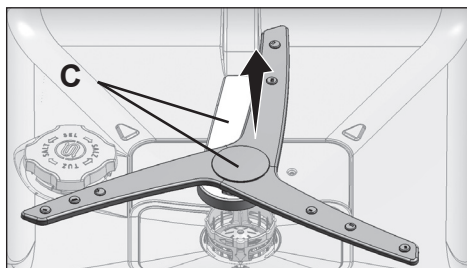

To remove and clean the lower impeller assembly together, hold by one hand from the (C) points shown in the figure and pull up to remove. After cleaning, follow these steps in reverse order to reinstall the impeller assembly.

Upper impeller

Check if the holes on the upper impeller (1) are clogged. If they are clogged, remove and clean the impeller. Turn its nut to left to remove the upper impeller.

Make sure that the nut is tightened well when installing the upper impeller.

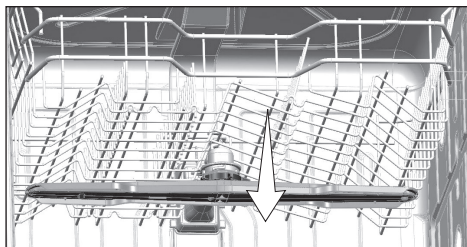
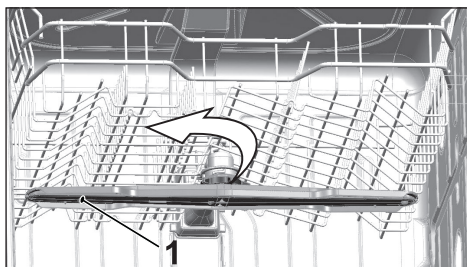

8 TROUBLESHOOTING

Machine does not start.

- Power cable is unplugged. >>> Check if the power cable is plugged in.
- Fuse is blown. >>> Check the fuses in your house.
- Water is cut. >>> Make sure that the water inlet tap is open.
- Door of the machine is open. >>> Make sure that you have closed the door of the machine.
- On / Off button is not pressed. >>> Make sure that you have turned on the machine by pressing the On / Off button.

Dishes are not washed clean

- Dishes are not placed orderly in the machine. >>> Load the dishes as described in the user manual.
- Selected programme is unsuitable. >>> Select a programme with a higher temperature and cycle time.
- Impellers are stuck. >>> Prior to starting the programme, turn the lower and upper impellers by hand to make sure that they rotate freely.
- Impeller holes are clogged. >>> Lower and upper impeller holes might be clogged with food remnants such as lemon pips. Clean the impellers regularly as illustrated in section "Cleaning and Care".
- Filters are clogged. >>> Check if the filter system is clean. Clean the filter system regularly as illustrated in section "Cleaning and Care".
- Filters are installed incorrectly. >>> Check the filter system and make sure that it is installed correctly.
- Baskets are overloaded. >>> Do not overload the baskets in excess of their capacity.
- Detergent is stored under unsuitable conditions. >>> If you are using powder detergent, do not store the detergent package in humid places. Keep it in a closed container if possible. For ease-of-storing, we recommend you to use tablet detergents.
- Detergent is not sufficient. >>> If you are using powder detergent, adjust the amount of detergent according to the soiling degree of your dishes and/or programme definitions. We recommend you to use tablet detergents for optimum results.
- Rinse aid is not sufficient. >>> Check the rinse aid indicator and add rinse aid if necessary. Increase the rinse aid setting if there is enough amount of rinse aid in the machine.
- Detergent dispenser lid is left open. >>> Make sure that the detergent dispenser lid is closed tightly after adding detergent.

Dishes are not dry at the end of cycle

- Dishes are not placed orderly in the machine. >>> Place your dishes in a way that no water will accumulate in them.
- Rinse aid is not sufficient. >>> Check the rinse aid indicator and add rinse aid if necessary. Increase the rinse aid setting if there is enough amount of rinse aid in the machine.

- Machine is unloaded right after the programme is over. >>> Do not unload your machine right after washing process is completed. Slightly open the door and wait for evacuation of the steam inside for a while. Unload the dishes after the pieces cool down to a touchable level. Start unloading process from the lower basket. Thus, dropping of water remained on a piece at upper basket onto the pieces at lower basket is prevented.
- Selected programme is unsuitable. >>> Since rinsing temperature is low at programmes with short duration, drying performance will also be low. Select programmes with longer duration for a higher drying performance.
- Surface quality of the kitchen utensils is deteriorated. >>> Desired washing performance can not be obtained on kitchen utensils with deteriorated surfaces and it is not suitable to use such utensils in terms of hygiene as well. Also, water can not flow easily on deteriorated surfaces. It is not recommended to wash such kitchen utensils in dishwasher.



It is normal that drying complaints can be experienced with Teflon kitchen utensils. It is associated with the structure of Teflon. Since the surface tensions of Teflon and water are different, water droplets will remain as beads on the Teflon surface.

Tea, coffee or lipstick stains remain on dishes.

- Selected programme is unsuitable. >>> Select a programme with a higher temperature and cycle time.
- Surface quality of the kitchen utensils is deteriorated. >>> Tea and coffee stains or other dye spots may not be cleaned in dishwasher when they have penetrated in deteriorated surfaces. Desired washing performance can not be obtained on kitchen utensils with deteriorated surfaces and it is not suitable to use such utensils in terms of hygiene as well. It is not recommended to wash such kitchen utensils in dishwasher.
- Detergent is stored under unsuitable conditions. >>> If you are using powder detergent, do not store the detergent package in humid places. Keep it in a closed container if possible. For ease-of-storing, we recommend you to use tablet detergents.

Lime traces remain on dishes and glassware gains a misty appearance

- Rinse aid is not sufficient. >>> Check the rinse aid indicator and add rinse aid if necessary. Increase the rinse aid setting if there is enough amount of rinse aid in the machine.
- Water hardness setting is low or salt level is insufficient >>> Measure the hardness of the supply water appropriately and check the water hardness setting.
- Salt leakage exists. >>> Pay attention not to spill salt around the salt filling hole while adding salt. Make sure that the salt reservoir lid is tightly closed after finishing the filling process. Run the prewash programme to remove the salt that spilled inside the machine. Since the salt granules that will remain under the lid will dissolve during prewash, causing the lid loosen, check the lid once again at the end of the programme.

There is a different odour in the machine



A new machine has a peculiar odour. It will fade out after a couple of washes.

- Filters are clogged. >>> Check if the filter system is clean. Clean the filter system regularly as illustrated in section "Cleaning and Care".
- Dirty dishes are kept in dishwasher for 2-3 days. >>> If you are not going to start the machine right after you have put the dishes into it, remove the remnants on the dishes and run the Prewash programme without detergent every 2 days. In such cases, do not close the door of the machine completely in order to avoid odour build up in machine. You can also use commercially available odour removers or machine cleaners.

Rust, discoloration or surface deterioration occurs on dishes

- Salt leakage exists. >>> Salt may cause deterioration and oxidation on metal surfaces. Pay attention not to spill salt around the salt filling hole while adding salt. Make sure that the salt reservoir lid is tightly closed after finishing the filling process. Run the prewash programme to remove the salt that spilled inside the machine. Since the salt granules that will remain under the lid will dissolve during prewash, causing the lid loosen, check the lid once again at the end of the programme.
- Salty food remnants have remained on dishes for a long time. >>> If cutlery soiled with such foods will be kept waiting in machine, dirt must be removed by prewash or dishes must be washed without being kept waiting.
- Electric installation is not grounded. >>> Check if your machine is connected to the actual grounding line. Otherwise, the static electric created in the product causes arcs on the surfaces of metal items creating pores, removing the protective cover on the surface and causing discoloration.
- Intensive cleansers such as bleaches are used. >>> Protective cover on metal surfaces gets damaged and loses its efficiency in time when it gets in contact with cleansers such as bleach. Do not wash your dishes with bleach.
- Metal items particularly knives are used for purposes other than their intended uses. >>> Protective cover on the edges of knives may get damaged when they are used for purposes such as opening cans. Do not use metal kitchen utensils out of their intended uses.
- Cutlery are made of low quality stainless steel. >>> Corrosion on such items is inevitable; they should not be washed in dishwashers.
- Kitchen utensils that are already corroded are washed in dishwasher. >>> Rust on a corroded item can migrate to other stainless steel surfaces and cause corrosion on those surfaces as well. Such items should not be washed in dishwashers.

Detergent remains in detergent dispenser.

- Detergent dispenser was damp when adding detergent. >>> Make sure that the detergent dispenser is dried well prior to filling it with detergent.
- Detergent is added long before the washing process. >>> Pay attention to add detergent shortly before start-up of the washing.
- Opening of the detergent dispenser lid is prevented during washing. >>> Place the dishes in a way that will not prevent the detergent dispenser lid from opening and the water going

into the machine from impellers.

- Detergent is stored under unsuitable conditions. >>> If you are using powder detergent, do not store the detergent package in humid places. Keep it in a closed container if possible. For ease-of-storing, we recommend you to use tablet detergents.
- Impeller holes are clogged. >>> Lower and upper impeller holes might be clogged with food remnants such as lemon pips. Clean the impellers regularly as illustrated in section "Cleaning and Care".

Decorations and ornaments on kitchen utensils are being erased.



Decorated glasses and decorated lustre porcelains are not suitable for washing in the dishwasher. Manufacturers of some glassware and porcelain tableware items do not recommend washing such kitchen utensils in the dishwashers either.

Dishes are scratched.



Kitchen utensils that contains or are made of aluminium should not be washed in dishwasher.

- Salt leakage exists. >>> Pay attention not to spill salt around the salt filling hole while adding salt. Spilled salt can cause scratches. Make sure that the salt reservoir lid is tightly closed after finishing the filling process. Run the prewash programme to remove the salt that spilled inside the machine. Since the salt granules that will remain under the lid will dissolve during prewash, causing the lid loosen, check the lid once again at the end of the programme.
- Water hardness setting is low or salt level is insufficient >>> Measure the hardness of the supply water appropriately and check the water hardness setting.
- Dishes are not placed orderly in the machine. >>> When placing the glasses and other glassware into the basket lean them not against other dishes but the edges or racks of the basket or the glass support tines. Striking of the glasses to each other or to other dishes due to the impact of water during washing can cause breaks, or scratches on their surfaces.

A smear remains on glasses that resembles milk stain which can not be removed when wiped by hand. A bluish / rainbow appearance occurs when the glass is pointed to light.

- Excessive rinse aid is used. >>>Lower rinse aid setting. Clean the spilled rinse aid when adding rinse aid.
- Corrosion has occurred on glass due to soft water. >>> Measure the hardness of the supply water appropriately and check the water hardness setting. If your supply water is soft (<5 dH), do not use salt. Choose programmes that wash in higher temperatures (e.g. 60-65 °C). You can also use glass protective detergents that are commercially available.

Foam forms in the machine.

- Dishes are washed with hand-wash detergent by hand but not rinsed before placing them

into the machine. >>> Hand-wash detergents do not contain antifoam. There is no need to hand-wash the dishes before placing them into the machine. Removing the coarse soil on the dishes under tap water, with a tissue paper or fork will be sufficient.

- Rinse aid has spilled into the machine when adding rinse aid. >>> Take care that rinse aid is not spilled in the machine when you are filling it. Clean any spilled rinse aid with the help of a tissue paper/towel.
- Lid of the rinse aid reservoir is left open. >>> Make sure that the lid of the rinse aid reservoir is closed after adding rinse aid.

Kitchen utensils are broken.

- Dishes are not placed orderly in the machine. >>> Load the dishes as described in the user manual.
- Baskets are overloaded. >>> Do not overload the baskets in excess of their capacity.

Water remains in the dishwasher at the end of the programme.

- Filters are clogged. >>> Check if the filter system is clean. Clean the filter system regularly as illustrated in section "Cleaning and Care".
- Discharge hose is clogged/blocked. >>> Check the discharge hose. If necessary, remove the discharge hose, clear the blockage and insert it as illustrated in the user manual.



If you cannot eliminate the problem although you follow the instructions in this section, consult your dealer or the Authorised Service Agent. Never try to repair a nonfunctional product yourself.

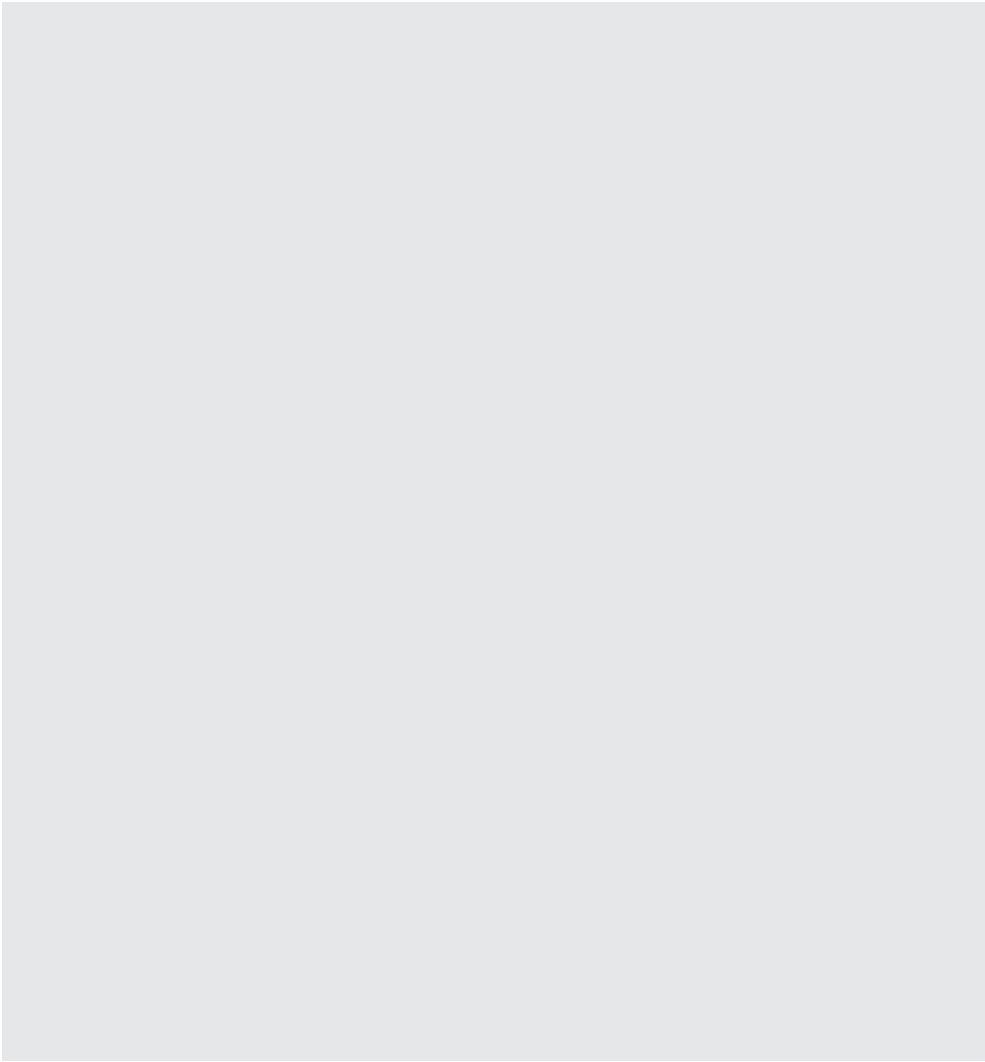

FOR A GOOD REASON

GRUNDIG

www.grundig.com